

# Soundweb™ London BLU-101

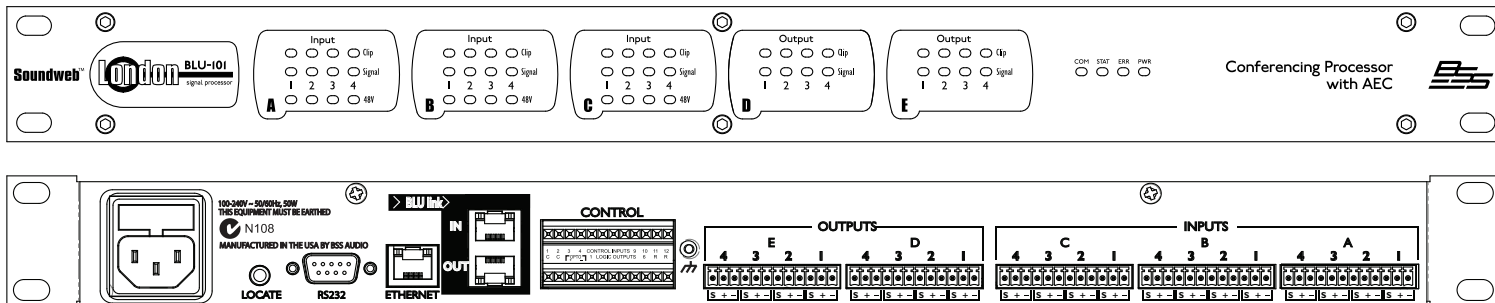

**OVERVIEW:**

The Soundweb London BLU-101 offers a fixed configuration of 12 analog inputs and 8 analog outputs, configurable signal processing, AEC processing, and a high bandwidth, fault tolerant digital audio bus.

The BLU-101 has open architecture which is fully configurable through HiQnet™ London Architect. A rich palette of processing and logic objects and a “drag and drop” method of configuration provide a simple and familiar design environment.

The BLU-101 contains dedicated AEC processing for up to 12 independent AEC algorithms. The AEC algorithm can be applied to signals coming from the local analog inputs or from the digital audio bus. 12 individual AEC references (one per algorithm) allow the user to provide a solution for multiple conferencing spaces using a single device.

Automatic Gain Control (AGC) and Noise Cancellation (NC) are also provided per AEC algorithm. AGC ensures that microphone levels remain at an optimum level, and NC removes steady state noise (such as from a projector fan or air conditioning device) from the signal path.

This processor features a low latency, fault tolerant digital audio bus of 48 channels which uses standard Category 5e cabling giving a distance of 100m between compatible devices. Fiber media converters can be used to increase the distance between devices to over 40km.

The BLU-101 is compatible with the entire Soundweb London family and its 48 channel digital audio bus represents channels 1-48 of the larger 256 channel digital audio bus when integrated with the BLU-800, BLU-320, BLU-160, BLU-120, BLU-BIB and BLU-BOB devices.

Analog Inputs provide software configurable gain in 6dB steps up to +48dB per channel and software selectable Phantom Power per channel.

Phantom Power, Signal Present and Clip information per channel is easily accessible, without the requirement for a PC, from clear front panel LED indication. A bi-directional locate function allows devices to be identified both from and within HiQnet London Architect.

12 Control Inputs and 6 Logic Outputs allow the BLU-101 to be integrated with GPIO compatible devices. The Soundweb London Interface Kit, comprehensive documentation which details how Soundweb London systems can be integrated with third party control systems, is included within the installation of HiQnet London Architect.

The BLU-101 and the other members of the Soundweb London family provide the building blocks of the perfectly tailored system solution.

**KEY FEATURES:**

- 12 Analog Inputs (with 48v Phantom Power per Channel)
- 8 Analog Outputs
- Configurable Signal Processing
- 12 Channels of AEC Processing with Auto Gain Control and Noise Cancellation
- Rich Palette of Processing and Logic Objects
- 48 Channel, Low Latency, Fault Tolerant Digital Audio Bus
- Clear Front Panel LED Indication
- Bi-Directional Locate Functionality
- 12 Control Inputs and 6 Logic Outputs for GPIO Integration
- Soundweb London Interface Kit for Third Party Control System Integration (Documentation)
- HiQnet Device
- Configuration, Control and Monitoring from HiQnet London Architect



# Soundweb™ London BLU-101

## TECHNICAL SPECIFICATIONS:

### Front Panel Led Indicators:

Per Input: Signal Present, CLIP, 48V (Input only)

Other: COM, STAT, ERR, PWR

**Analog Inputs:** 12 electronically balanced on Phoenix Combicon removable screw connectors

Mic/Line Inputs: Nominal gain 0dB, electronically switchable up to +48dB, in +6dB steps

Input Impedance: 3.0k $\Omega$

Maximum Input Level: +20dBu with 0dB input gain, +8dBu with 12dB gain

CMRR: >75dB at 1KHz

Input Noise (E.I.N.): <-125dBu typical with 150 $\Omega$  source

Phantom Power: 48V nominal, selectable per input

A/D Latency: 37/Fs [0.77ms@48k]

**Analog Outputs:** 8 electronically balanced on Phoenix/Combicon removable screw connectors

Maximum Output Level: +19dBu

Frequency Response: 20Hz-20KHz (+0.5dB/-1dB)

THD: <0.01% 20Hz to 20KHz, +10dBu output

Dynamic Range: 108dB typical, 22Hz-22KHz unweighted

Crosstalk: <-75dB

Output Impedance: 40 $\Omega$  balanced and 20 $\Omega$  unbalanced

D/A Latency: 29/Fs [0.60ms@48k]

**AEC Processing:** 12 independent algorithms

AEC Processing Latency (Original 8k Algorithm): 2385/Fs [49.69ms@48k]

AEC Processing Latency (Full Bandwidth Algorithm): 1609/Fs [33.52ms@48k]

Tail Length: 200 ms

Average Convergence Rate: 49 dB/s (Net convergence over multiple FFT bands)

**Control Ports:** 12 inputs and 6 outputs

Control Input Voltage: 0 to 4.5v

Control Input Impedance: 4.7k $\Omega$  to +5V (2-wire mode), >1M $\Omega$  (3-wire mode)

Logic Output Voltage: 0 or +5V unloaded

Logic Output Impedance: 440 $\Omega$

Logic Output Current: 10mA source, 60mA sink

**Watchdog Output:** Phoenix/Combicon connector for failsafe control

Opto Output Current: 14mA maximum

Withstanding Voltage: 80V maximum (Off)

Series Impedance: 220 $\Omega$  (isolated)

### Control Network:

Connectors: RJ45 Ethernet connector

Maximum Cable Length: 100m/300ft on Category 5 cable between device and Ethernet switch

### BLU link:

Connectors: 2 x RJ45 Ethernet connectors

Maximum Cable Length: 100m/300ft on Category 5e cable between devices

Max. Number of Nodes: 60

Latency: 11/Fs [0.23ms@48k]

Pass Through Latency: 4/Fs [0.08ms@48k]

### Power and Dimensions:

Mains Voltage: 100-240V AC, 50/60Hz

Power Consumption: <55VA

BTU Rating: <188 BTU/hr

Operating Temp. Range: 15 (59) to 35 (95) degrees C (degrees F)

Dims: (H(U) x W x D): 1.75" (45mm)(1U) x 19" (483mm) x 12.5" (318mm)

Weight: 9.1 lbs / 4.1 kg

BSS Audio incorporates high quality mechanical fans in some products. All mechanical fans have a limited life expectancy. We recommend annual inspection of fans for dust occlusion and excessive noise. Fan assemblies should be replaced after six to ten years of use. Environmental factors such as elevated temperature, dust, and smoke can adversely affect fan life. Systems exposed to these conditions should be inspected more frequently. Fan replacement can be performed either at the factory or by an experienced technician in the field. Please contact BSS Technical Support for more information on purchasing replacement parts or product service.

BSS Audio has a policy of continued product improvement and accordingly reserves the right to change features and specifications without prior notice.