

# DRD2 & SquareFrame Alt/EM

## General Recessed LED Downlight

Alternate Dimming and/or Emergency Lighting  
DRDHNJS Square Junction Box

Project:	Type:
Product Code:	Date:

Spec Sheet V-07.01.20

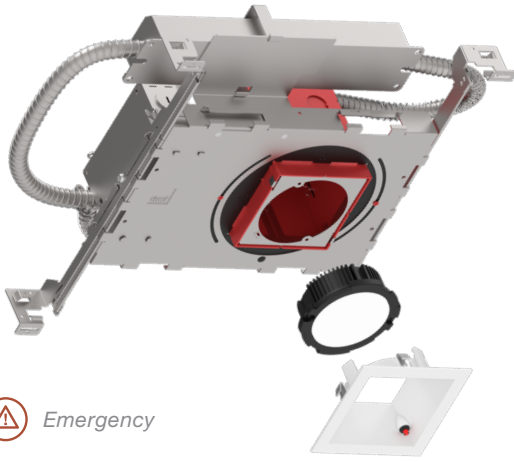









Emergency



Alternate Dimming

- Combines the performance of a premium light engine with an intelligent design that makes it simple to install, maintain or replace
- Maintains all the standard SquareFrame features
- Offers enhanced dimming protocol compatibility including 0-10V and Lutron Hi-Lume® 1%
- Can provide lighting for more than 90 minutes after power failure - enough to meet common safety regulations like NFPA 101

<b>Application</b> New Construction	<b>Aperture</b> 4" Square Deep Junction Box
<b>Delivered Lumens</b> 750 lm (10.8W), 1000 lm (12.8W)	<b>Color Quality</b> 93+ CRI, 2-step SDCM
<b>Color Temperature</b>  2700K   3000K   3500K   4000K	<b>Light Distribution</b>  General   Wall Wash
<b>Input Voltage</b> 120/277V	<b>Dimming</b> 0-10V 1%, Lutron Hi-lume® 1%
<b>Warm Dim Option</b>  3000K – 1800K, 800 lm (12.0W)	<b>Emergency Lighting</b> Emergency LED Driver for lighting up to 90 minutes in event of power failure
<b>Trims</b> Emergency, Square, Round on Square, Pinhole, Beveled Pinhole, Wall Wash, Decorative, Flangeless, Dead Front	<b>Trim Finish</b> White, Black, Silver, Custom
<b>Housing Ratings</b>  Code compliant for use in fire-rated assemblies up to a maximum of 2-hours  STC/IIC Sound Rated  ASTM E283 Certified Air Tight  IC (Insulation Contact) Rated	
<b>Module Ratings</b>  UL Listed for Wet Location	

### Standards



### Guarantee

50,000 hrs | 5 years

### Additional Options

TRIAC/ELV Dimming, Apex Series Lighting, Adjustable Lighting



# DRD2 & SquareFrame Alt/EM

## General Recessed LED Downlight

Alternate Dimming and/or Emergency Lighting

DRDHNJS Square Junction Box

### PRODUCT BUILDER

#### HOUSING

PRODUCT CODE	APPLICATION	APERTURE	DRIVER	OPTION	
<b>DRDH</b>	Housing	<b>N</b> New Construction	<b>JS</b> Square Junction Box	<b>7O</b> 0-10V, 750 lm <b>8OW</b> 0-10V, 800 lm <b>10O</b> 0-10V, 1000 lm <b>7C</b> Lutron LDE1 <sup>1</sup> , 750 lm <b>8CW</b> Lutron LDE1 <sup>1</sup> , 800 lm <b>10C</b> Lutron LDE1 <sup>1</sup> , 1000 lm <b>7L</b> Lutron LTEA2W <sup>2</sup> , 750 lm <b>8LW</b> Lutron LTEA2W <sup>2</sup> , 800 lm <b>10L</b> Lutron LTEA2W <sup>2</sup> , 1000 lm	<b>[Blank]</b> None <b>EM</b> EM Driver, Integrated Test Switch <b>EMS</b> EM Driver, Remote Test Switch

#### MODULE

PRODUCT CODE	LUMENS	CRI	CCT	DRIVER	
<b>DRD2M</b>	Module	<b>7</b> 750 lm <b>10</b> 1000 lm	<b>9</b> 93+ CRI	<b>27</b> 2700K <b>30</b> 3000K <b>35</b> 3500K <b>40</b> 4000K	<b>A</b> Alternate

#### Warm Dim Option

<b>DRD2M</b>	Module	<b>08</b> 800 lm	<b>9</b> 93+ CRI	<b>3W</b> 3000K - 1800K	<b>A</b> Alternate
--------------	--------	------------------	------------------	-------------------------	--------------------

#### TRIM

PRODUCT CODE	SHAPE	APERTURE	STYLE	FINISH	OPTION	
<b>DRD2T</b>	Trim	<b>S</b> Square	<b>JS</b> Square Junction Box	<b>S</b> Standard <b>Q</b> Round on Square <b>P</b> Pinhole <sup>3</sup> <b>B</b> Beveled Pinhole <sup>3</sup> <b>W</b> Wall Wash <sup>3</sup>	<b>WH</b> White <b>BK</b> Black <b>SW</b> Silver Reflector, White Flange <b>CC</b> Custom Color	<b>[Blank]</b> None <b>DCF</b> Decorative: Closed, Frosted <sup>3,4</sup> <b>DCCF</b> Decorative: Closed, Clear, Frosted inside <sup>3,4</sup> <b>FL</b> Flangeless <sup>3,5</sup> <b>EM</b> Emergency <sup>3,4</sup> <b>DF</b> Dead Front <sup>3,4</sup>

**DRD2M-DF** Flangeless Mud Plate (Required with Flangeless Trim)

<sup>1</sup> Lutron LDE1 refers to Lutron Hi-lume 1% EcoSystem LED driver with Soft-on, Fade-to-Black™

<sup>2</sup> Lutron LTEA2W refers to Lutron Hi-lume 1% 2-wire LED driver, 120V only

<sup>3</sup> Only available in White or Custom Color finish

<sup>4</sup> Only available in Standard style

<sup>5</sup> Requires DRD2M-DF Mud Plate



# DRD2 & SquareFrame Alt/EM

## General Recessed LED Downlight

Alternate Dimming and/or Emergency Lighting  
DRDHNJS Square Junction Box

### HOUSING

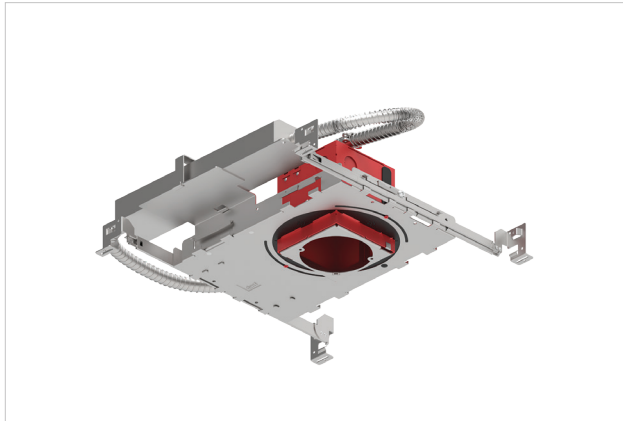

## SquareFrame

Alternate Dimming and/or Emergency Lighting  
Deep Junction Box

### DRDHNJS

#### SUMMARY

**JUNCTION BOX:** Equipped with (8) trade size knockouts (four (1/2") side, two (3/4") top, two (1/2") top) and (4) Romex knockouts (side) to allow straight conduit runs. Approved for 8 (four in, four out) #12 AWG.

**MOUNTING:** Pre-installed mounting brackets allow vertical adjustment of bar hangers up to 1".

**CEILING:** 1/2" up to 1 3/4"

**CUTOUT:** 4 1/4" (108mm) square opening

**LISTINGS:** Metallic outlet box certified UL514A, code compliant for use in fire-rated assemblies for up to 2-hours, STC/IIC Sound Rated, ASTM E283 certified Air Tight, IC (Insulation Contact) rated

**INPUT VOLTAGE:** 120/277V, 50/60Hz

**MAX INPUT CURRENT (120V):** 0.090 amps (750 lm), 0.107 amps (1000 lm), 0.11 amps (800 lm Warm Dim)

**MAX INPUT CURRENT (277V):** 0.042 amps (750 lm), 0.050 amps (1000 lm), 0.047 amps (800 lm Warm Dim)

**POWER FACTOR:** Greater than 0.9

**TOTAL HARMONIC DISTORTION:** Less than 20%

**WARRANTY:** 5 year limited warranty

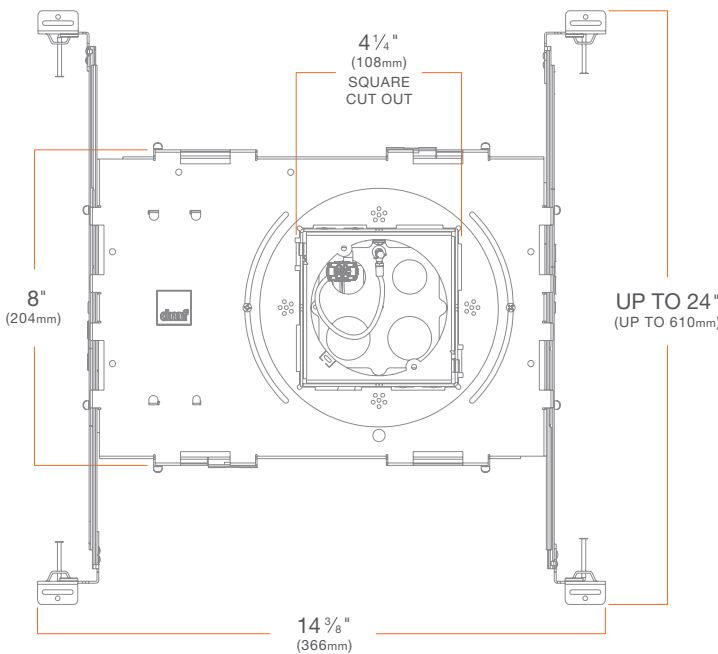
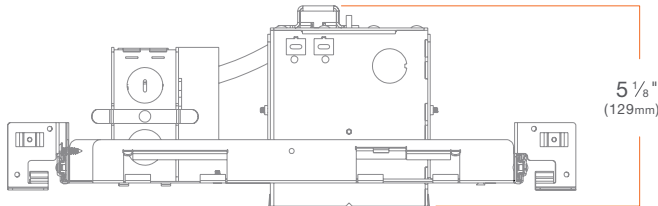

### MODULE



## DRD2

General LED Module

### DRD2M

#### SUMMARY

**LED:** Cree® LED

**DELIVERED LUMENS (w Trim):** 750 lm (10.8W), 1000 lm (12.8W)

**EFFICACY:** 80 lm/W, 85 lm/W

**COLOR QUALITY:** 93+ CRI, 2-step SDCM

**CCT:** 2700K, 3000K, 3500K, 4000K

**CONNECTOR:** PowerPlug® Luminaire Disconnect Model 102

**DIMMING:** Down to less than 1% for 0-10V or Lutron Hi-lume® 1%

**EMERGENCY LIGHTING:** Optional Emergency LED Driver for lighting up to 90 minutes in event of power failure

**AMBIENT OPERATING TEMPERATURE:** -20°C to 40°C

**PHOTOMETRIC TESTING:** Tested in accordance to IESNA LM-79-2008

**LISTINGS:** ENERGY STAR® qualified, California Title 24 2016 JA8 compliant, UL Listed for Wet Location (with flanged and non-EM trims only), cULus Listed

**LIFETIME:** 50,000 hours at 70% lumen maintenance

**WARRANTY:** 5 year limited warranty

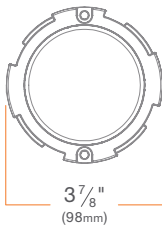
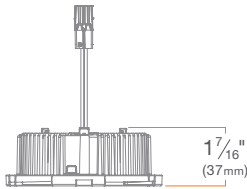

#### ● WARM DIM OPTION

**LED:** Bridgelux LED, **DELIVERED LUMENS (w Trim):** 800 lm (12.0W),

**EFFICACY:** 70 lm/W, **CCT RANGE:** 3000K - 1800K

### TRIM

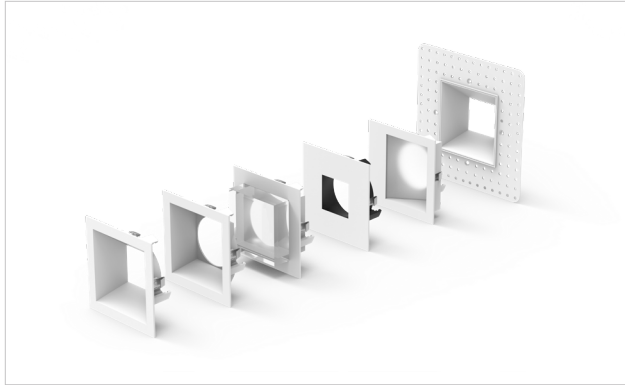

## SquareFrame Trims

Recessed LED Downlight Trims

### DRD2T

#### SUMMARY

**CONSTRUCTION:** Die-cast aluminum

**INSTALLATION:** Twist & Lock (flanged trims only)

#### Square Trim

**DRD2TSJSSWH**

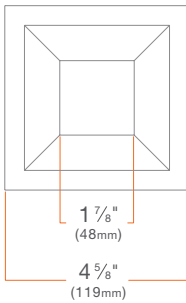
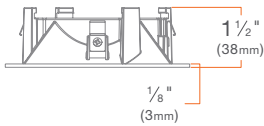

#### Round on Square Trim

**DRD2TSJSQWH**

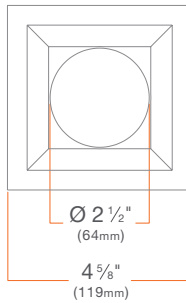
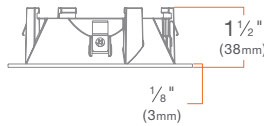

#### Pinhole Trim

**DRD2TSJSPWH**

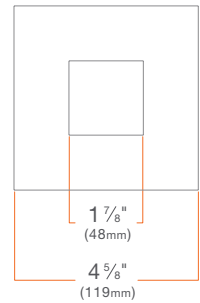
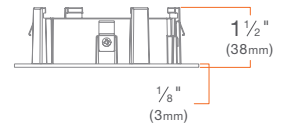

#### Beveled Pinhole Trim

**DRD2TSJSBWH**

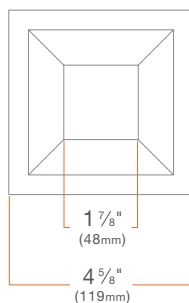
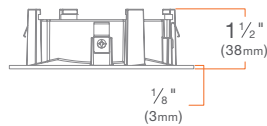

#### Wall Wash Trim

**DRD2TSJSWWH**

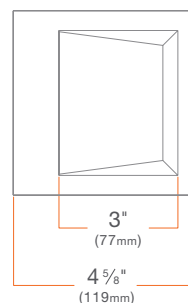
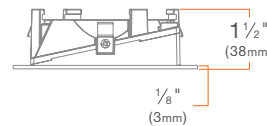

### TRIM

#### Square Flangeless Trim Insert

**DRD2TSJSSWHFL**

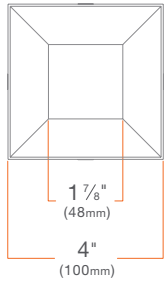
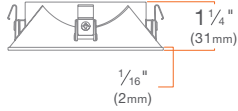

#### Round on Square Flangeless Trim Insert

**DRD2TSJSQWHFL**

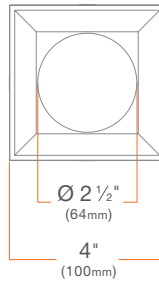
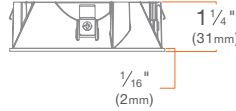

#### Pinhole Flangeless Trim Insert

**DRD2TSJSPWHFL**

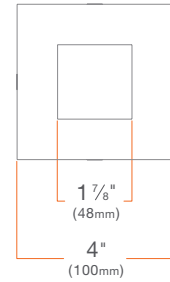
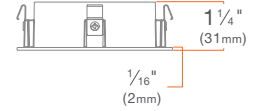

#### Beveled Pinhole Flangeless Trim Insert

**DRD2TSJSBWHFL**

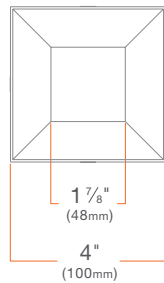
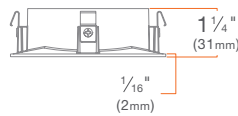

#### Wall Wash Flangeless Trim Insert

**DRD2TSJSWWHFL**

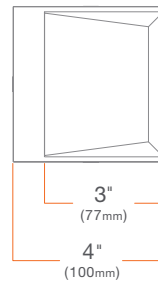
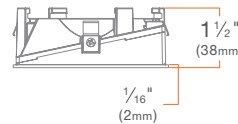



### TRIM

#### Flangeless Mud Plate

DRDHX-MUD-SFL

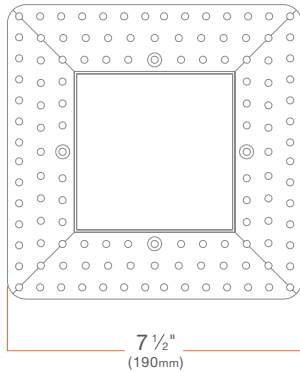

#### Decorative Closed Trim

Frosted: DRD2TRJDSWHDCF

Clear, Frosted Sides: DRD2TRJDSWHCCF

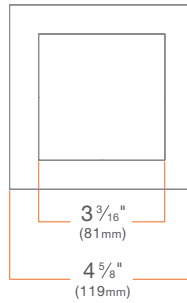
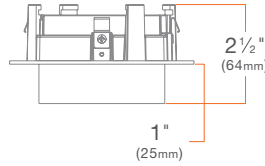

#### Emergency Trim

DRD2TSJSSWHEM

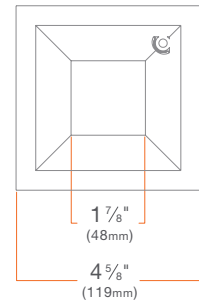
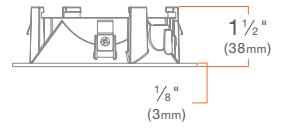



# DRD2 & SquareFrame Alt/EM

## General Recessed LED Downlight

Alternate Dimming and/or Emergency Lighting

DRDHNJS Square Junction Box

### PHOTOMETRY

#### DRD2 750 lm, 3000K **DRD2M7930** / Round on Square Trim White **DRD2TSJSQWH**

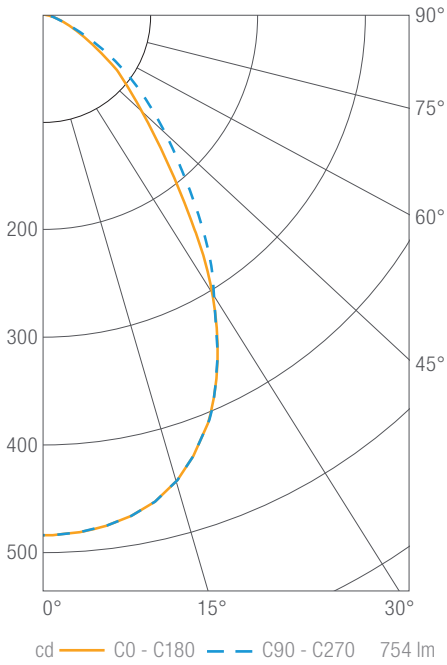

#### Luminous Intensity

Gamma	C 0°
0°	484
5°	481
10°	473
15°	455
20°	424
25°	379
30°	319
35°	248
40°	181
45°	134
50°	103
55°	75
60°	49
65°	30
70°	20
75°	14
80°	9
85°	4
90°	0

Values in candela

#### Zonal Lumen Summary

Zone	Lumens	Luminaire %
0-30	346	46
0-40	507	67
0-60	700	93
0-90	754	100
0-180	754	100

#### Illuminance Chart

Distance from LED	Foot Candles	Diameter
3'	54	4.3'
6'	13	8.5'
9'	6	12.8'
12'	3	17.1'

Beam Angle: 71°

#### DRD2 - Warm Dim 800 lm, 3000K **DRD2M0893W** / Round on Square Trim White **DRD2TSJSQWH**

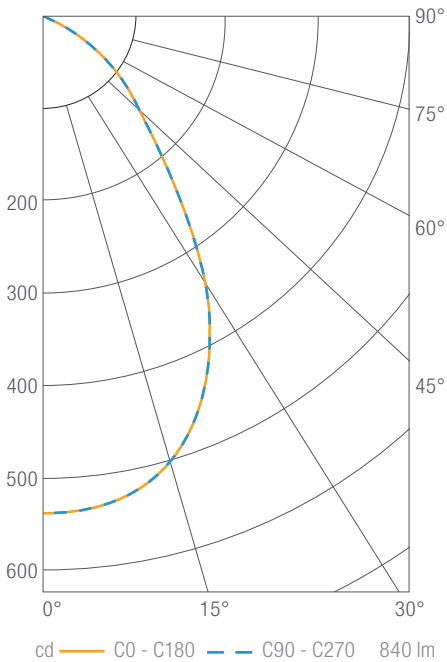

#### Luminous Intensity

Gamma	C 0°
0°	539
5°	535
10°	526
15°	506
20°	472
25°	422
30°	357
35°	277
40°	203
45°	151
50°	117
55°	86
60°	55
65°	33
70°	22
75°	16
80°	10
85°	4
90°	0

Values in candela

#### Zonal Lumen Summary

Zone	Lumens	Luminaire %
0-30	386	46
0-40	565	67
0-60	779	93
0-90	840	100
0-180	840	100

#### Illuminance Chart

Distance from LED	Foot Candles	Diameter
3'	60	4.3'
6'	15	8.5'
9'	7	12.8'
12'	4	17.1'

Beam Angle: 71°

#### Lumen Scaling

DRD2M7 (750 lm)	DRD2M10 (1000 lm)
1.00	1.33

#### CCT Scaling

DRD2M7927 (2700K)	DRD2M7930 (3000K)	DRD2M7935 (3500K)	DRD2M7940 (4000K)
0.93	1.00	1.00	1.07





### 0-10V DIMMER COMPATIBILITY

#### Recommended 0-10V Dimmers (Dims down to 1% nominal measured light output)

Brand	Series	Model Number	Max Load DRD2M7	Max Load DRD2M10
Legrand	Titan	CD4FB	80	65
Leviton	IllumaTech	IP710-DLZ	40	30
Lithonia	Synergy	ISD BC	35	30
Lutron	Diva	DVTV	60	50
	Nova	NFTV	60	50
	Nova	NTSTV-DV	60	50
	PowPak	RMJ-5T-DV	60	50

# SquareFrame System Options

The Perfect Square

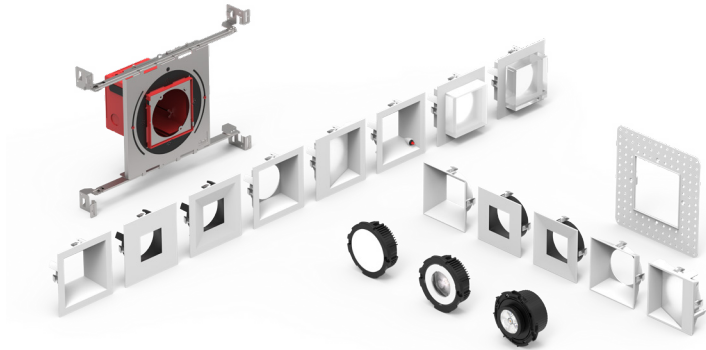

## General Recessed LED Downlight

### **DRD2 & SquareFrame**

DRDHNJS Square Junction Box

### **DRD2 & SquareFrame Alt/EM**

Alternate Dimming and/or Emergency Lighting

DRDHNJS Square Junction Box

## Apex Series Recessed LED Downlight

### **DRD2X & SquareFrame**

DRDHNJS Square Junction Box

### **DRD2X & SquareFrame Alt/EM**

Alternate Dimming and/or Emergency Lighting

DRDHNJS Square Junction Box

## Adjustable Recessed LED Downlight

### **DRD4 & SquareFrame**

DRDHNJS Square Junction Box

### **DRD4 & SquareFrame Alt/EM**

Alternate Dimming and/or Emergency Lighting

DRDHNJS Square Junction Box