

DRD5S & SurfaceFrame

Surface Mount LED Downlight

New Construction













DRDHNJO Octagonal Junction Box

Project:	Type:
Product Code:	Date:

V120122



- Thinnest-in-class DRD5S delivers the pure, smooth light and the elegant look of a high-end recessed downlight
- Features multiple ratings to meet the demands of a wide range of situations
- Ultra-low profile allows it to install in as little as 2" of ceiling space when 5/8" drywall is used

Application New Construction		Aperture 4" Octagonal Junction Box	
Delivered Lumens 750 lm (9.0W), 1000 lm (12.0W)		Color Quality 90+ CRI, < 3-step SDCM	
Color Temperature  2700K 3000K 3500K		Optics  General	
Input Voltage 120V only (TRIAC/ELV), 120/277V (0-10V)	Dimming TRIAC/ELV 5% 0-10V 1%	Emergency Lighting Optional Emergency LED Driver with integrated Test Switch for lighting up to 90 minutes in event of power failure	
Shape Round, Square		Finish White	Module Ratings  UL Closet Rating Compliant (750 lm only)  UL Listed for Wet Location
Housing Ratings			
 Code compliant for use in appropriate fire-rated assemblies up to a maximum of 2-hours	 STC/IC Sound Rated	 ASTM E283 Certified Air Tight	 IC (Insulation Contact) Rated
Standards   		Guarantee 50,000 hrs 5 years	Additional Options  Non-Conductive Dead Front



PRODUCT BUILDER

HOUSING

PRODUCT CODE		APPLICATION		APERTURE		OPTION	
<input type="text"/>		<input type="text"/>		<input type="text"/>		<input type="text"/>	
DRDH	Housing	N	New Construction	JO	SurfaceFrame Octagonal Junction Box	[Blank]	Integrated Driver
						70SEM	EM Driver ¹ , 0-10V, 750 lm
						100SEM	EM Driver ¹ , 0-10V, 1000 lm

LED MODULE

PRODUCT CODE		APERTURE		SHAPE		LUMENS		CRI		CCT		DRIVER	
<input type="text"/>		<input type="text"/>		<input type="text"/>		<input type="text"/>		<input type="text"/>		<input type="text"/>		<input type="text"/>	
DRD5S	Module	4	4" Aperture	R	Round	07	750 lm	9	90+ CRI	27	2700K	T	Integrated TRIAC/ELV, 120V only
				S	Square	10	1000 lm			30	3000K	O	Integrated 0-10V, 120/277V
										35	3500K	TDF	Integrated TRIAC/ELV, 120V only, Non-Conductive ²
												ODF	Integrated 0-10V, 120/277V, Non-Conductive ²
												EM	Emergency ¹ w/ Test Switch

¹ EM option (housing) and Emergency driver (module) must be selected together

² Only available for Round shape, 750 lm, 2700K or 3000K CCT



HOUSING

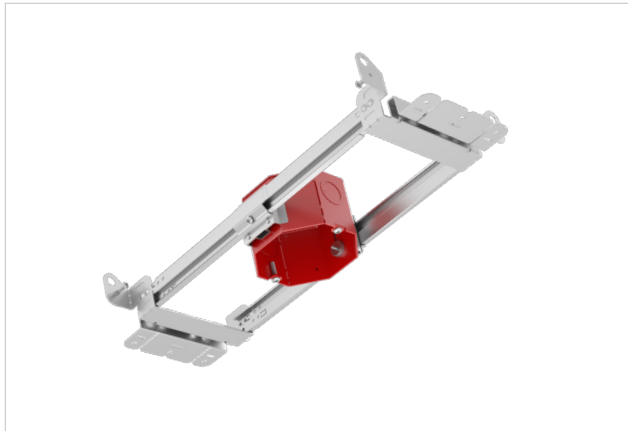

SurfaceFrame

New Construction Octagonal Junction Box

DRDHNJO

SUMMARY

JUNCTION BOX: Equipped with (4) 1/2" trade size knockouts (two side, two top) to allow straight conduit runs. Approved for 6 (three in, three out) #12 AWG 70°C through wiring conductors.

MOUNTING: Pre-installed mounting brackets allow vertical adjustment of bar hangers up to 1"

CEILING: 1/2" up to 1 3/4"

CUTOUT: 4 1/8" (105mm) octagonal opening

LISTINGS: Metallic outlet box certified UL514A, code compliant for use in appropriate fire-rated assemblies for up to 2-hours, STC/IIC Sound Rated, ASTM E283 certified Air Tight, IC (Insulation Contact) rated

WARRANTY: 5 year limited warranty

SurfaceFrame
DRDHNJO

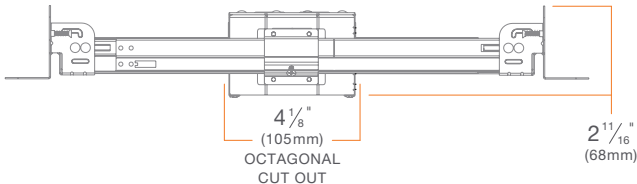

SurfaceFrame w/ Emergency Lighting
DRDHNJO EM

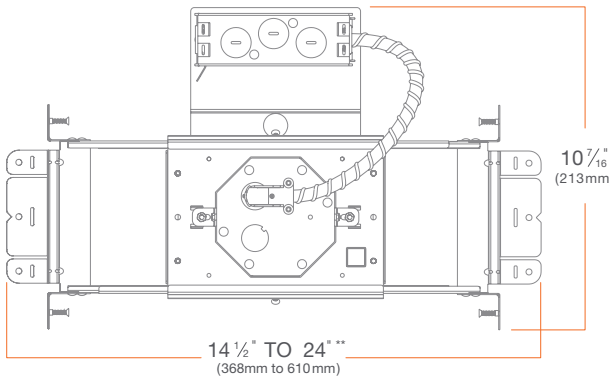
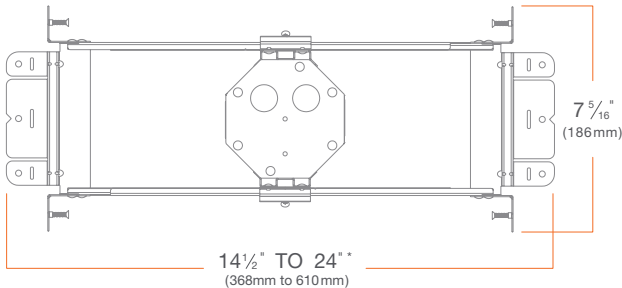
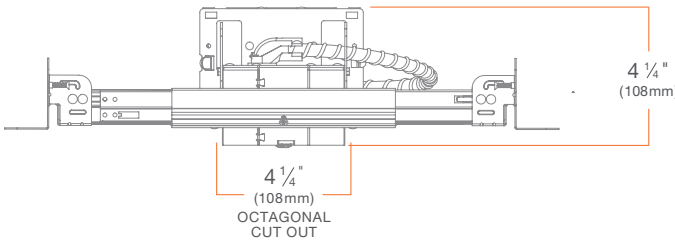

* Can be field cut to minimum 7 1/2" (191mm)

** Can be field cut to minimum 9" (229mm)

MODULE



DRD5S

Surface Mount LED Module

DRD5S

SUMMARY

LED: Optimized LED array

SHAPE: 4" Round, 4" Square

MODULE LUMENS: 750 lm (9.0W), 1000 lm (12.0W)

COLOR QUALITY: 90+ CRI, less than 3-step SDCM

CCT: 2700K, 3000K, 3500K

INPUT VOLTAGE: 120V only (TRIAC/ELV), 120/277V (0-10V)

DIMMING: Down to less than 5% for TRIAC/ELV at 120V, 1% for 0-10V at 120/277V

MAX INPUT CURRENT (120V): 0.075 amps, 0.1047 amps

MAX INPUT CURRENT (277V): 0.034 amps, 0.047 amps

POWER FACTOR: Greater than 0.9

TOTAL HARMONIC DISTORTION: Less than 20%

AMBIENT OPERATING TEMPERATURE: -20°C to 40°C

EMERGENCY LIGHTING: Optional Emergency LED Driver with Integrated Test Switch for lighting up to 90 minutes in event of power failure

PHOTOMETRIC TESTING: Tested in accordance to IESNA LM-79-2008

LISTINGS: ENERGY STAR® qualified*, California Title 24 2019 JA8 compliant, UL Listed for Wet Location, UL Closet Rating compliant (750 lm only), UL Certified US·CA

LIFETIME: 50,000 hours at 70% lumen maintenance

WARRANTY: 5 year limited warranty

* Refer to ENERGY STAR Certified light fixtures database

4" Round

DRD5S4R

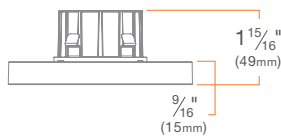

4" Square

DRD5S4S

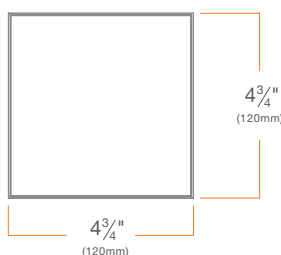
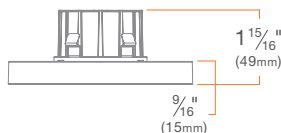

4" Round w/ EM Test Switch

DRD5S4R EM

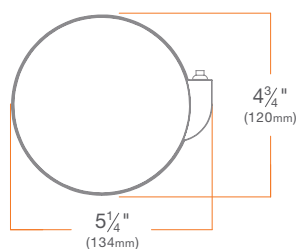
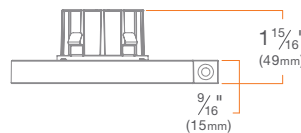

4" Square w/ EM Test Switch

DRD5S4S EM

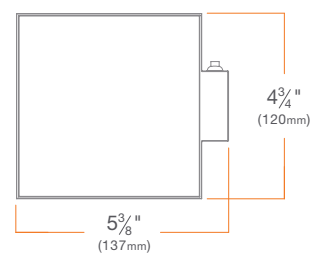
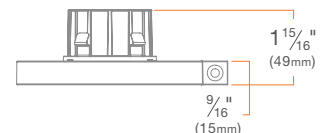



PHOTOMETRY

DRD5S 4" Round, 750 lm, 90 CRI, 3000K DRD5S4R07930

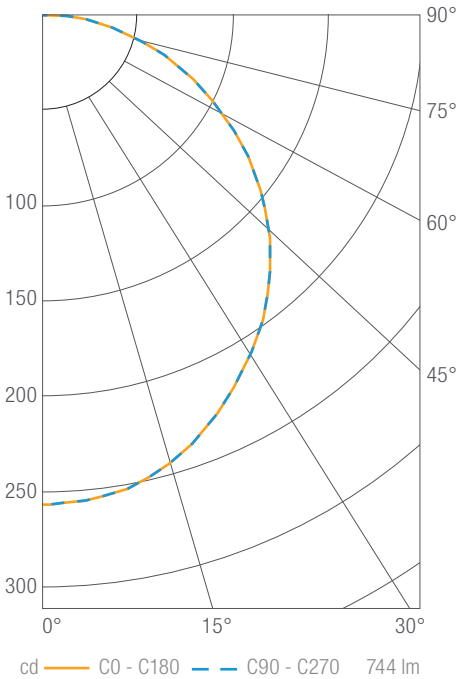

Luminous Intensity

Gamma	C 0°
0°	258
5°	256
10°	253
15°	247
20°	237
25°	226
30°	213
35°	200
40°	185
45°	169
50°	151
55°	132
60°	113
65°	93
70°	73
75°	54
80°	35
85°	18
90°	6

Values in candela

Zonal Lumen Summary

Zone	Lumens	Luminaire %
0-30	199	27
0-40	324	44
0-60	573	77
0-90	744	100
0-180	744	100

Illuminance Chart

Distance from LED	Foot Candles	Diameter
3.0'	29	8.8'
6.0'	7	17.7'
9.0'	3	26.5'
12.0'	2	35.3'

Beam Angle: 70°

DRD5S 4" Round, 1000 lm, 90 CRI, 3000K DRD5S4R10930

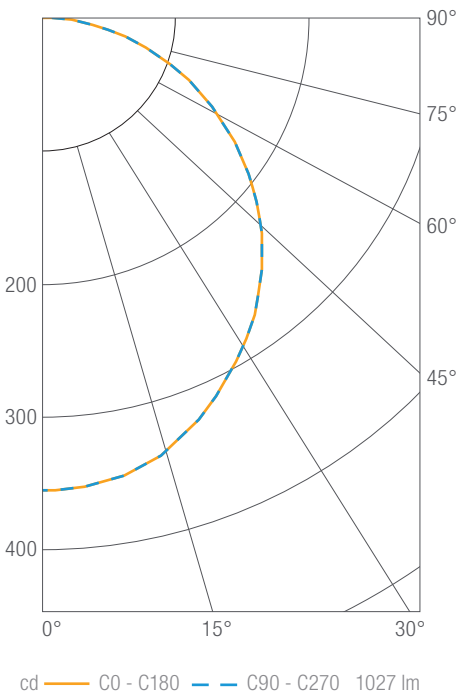

Luminous Intensity

Gamma	C 0°
0°	356
5°	354
10°	349
15°	340
20°	327
25°	312
30°	294
35°	276
40°	255
45°	233
50°	209
55°	183
60°	155
65°	128
70°	101
75°	74
80°	48
85°	25
90°	9

Values in candela

Zonal Lumen Summary

Zone	Lumens	Luminaire %
0-30	274	27
0-40	447	44
0-60	790	77
0-90	1027	100
0-180	1027	100

Illuminance Chart

Distance from LED	Foot Candles	Diameter
3.0'	40	8.8'
6.0'	10	17.7'
9.0'	4	26.5'
12.0'	2	35.3'

Beam Angle: 63°

**DIMMER COMPATIBILITY****Recommended Phase-control Dimmers** (Dims down to 5% nominal measured light output)

Brand	Series	Model Number	Max Load 750lm DRD5S4R07	Max Load 1000lm DRD5S4R10
Cooper	Aspire	9573	29	23
Leviton	Vizia	VPE06	64	48
Lutron	CL Series	AYCL-253, DVCL-253	26	20
	Grafik Eye 3000	QSGR-3P, QSGR-6P	31	24
	Grafik Sys / Homeworks	RPM-4U	44	35
	Maestro CL	MACL-153M, MSCL-OP153M, MSCL-VP153M	16	12

Compatible Phase-control Dimmers¹ (Dims down to 20% nominal measured light output)

Brand	Series	Model Number	Max Load 750lm DRD5S4R07	Max Load 1000lm DRD5S4R10
Cooper	Decorator	DLC03P, DAL06P	29	23
Legrand	Adorne	ADTP703	48	38
	Digital Light Management	LMRC-221	250	195
Leviton	IllumaTech	IPE04	32	25
	Vizia	VPE04	42	32
Lutron	CL Series	AYCL-153, CTCL-153, DVCL-153, LGCL-513, SCL-153, TGCL-513	15	11
	Maestro Wireless	MRF2-6ELV, MRF2-6CL	15	12
	Radio RA	RRD-6NA, RRD-6CL, RRD-6D	15	12
	Skylark Contour CL	CTCL-153P	15	12

¹ Dimmer compatibility reflects performance compatibility only. Please reference your local codes for application.



DIMMER COMPATIBILITY

Recommended 0-10V Dimmers (Dims down to 1% nominal measured light output)

Brand	Series	Model Number	Max Load 750lm DRD5S4R07	Max Load 1000lm DRD5S4R10
Legrand	Titan	CD4FB	200	150
Leviton	IllumaTech	IP710-DLZ	120	90
Lithonia	Synergy	ISD BC	120	90
Lutron	Diva	DVTV	100	75
	Nova	NFTV	200	150
	Nova	NTSTV-DV	100	75
	Vive-PowPak	RMJS-8T-DV-B	60	45
Watt Stopper	Micro-Decorator	DCLV1	60	45
	DLM	LMRC-211	100	75



SurfaceFrame Options

Shallow Recessed LED Downlight

DRD2 & SurfaceFrame

DRDHNJO Octagonal Junction Box

DRD2 & SurfaceFrame Alt/EM

Alternate Dimming and/or Emergency Lighting

DRDHNJO Octagonal Junction Box

Surface Mount LED Downlight

DRD5S & SurfaceFrame

DRDHNJO Octagonal Junction Box