

PRGS-455
PRSS-455

Projector Mount Kit

For projectors up to 50lb (22kg)



The PRGS-UNV Precision Gear Projector Mount or PRSS-UNV Projector Mount is kitted with the versatile CMJ455 Suspended Ceiling Plate Kit, which allows a projector to be mounted into a 2' x 2' false ceiling system. The kit offers hassle-free adjustability for both projector mount placement and image alignment. The projector mount can be placed anywhere within a standard ceiling grid, and the PRGS-455 offers precision gear image alignment that can be easily controlled by adjusting the knobs for tilt and roll. The kit can be used with or without an extension column and offers electrical knockouts.



Max load: 50lb (22kg)

FEATURES

- Fits most projectors up to 50lb (22kg)
- Two adjustment knobs that control projector image alignment (PRGS only)
- Specifications:
 - Pitch: +15°/-20°
 - Roll: ±5°
 - Swivel: 360° (during installation)
- Quick-release mechanism to easily service projector
- Cable management allows cables to be hidden by routing them through projector mount
- Security hardware included for theft prevention
- Includes Spider® Universal Adaptor Plate
- Includes tie wire for a 3' drop, turn buckles, and fasteners for mounting

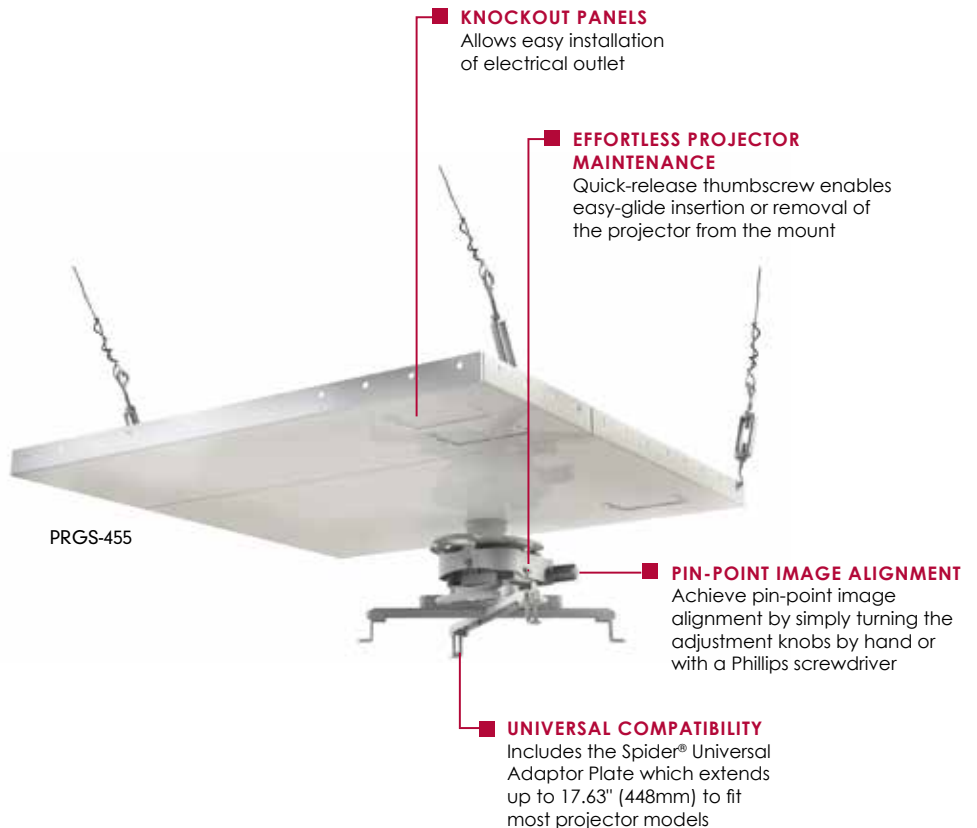

PRGS-455



PRSS-455

Patented. Utility Patent No:
European Union Patent - 001309686-0001 & 001309686-0002,
Taiwan Patent - D136395, US Patent - D597,582 - D609,552 - D611,084.



CLICK: peerless-av.com

CALL: 800.865.2112

FAX: 800.359.6500

peerless-AV®

Model Numbers

WARRANTY: Limited 5-year

PRGS-455:	Projector Mount Kit for projectors up to 50lb (22kg) - PRGS-UNV Precision Gear Projector Mount kitted with CMJ455 Suspended Ceiling Plate
PRSS-455:	Projector Mount Kit for projectors up to 50lb (22kg) - PRSS-UNV Projector Mount kitted with CMJ455 Suspended Ceiling Plate

Product Specifications

	DIMENSIONS (W x H x D)	PRODUCT WEIGHT	LOAD CAPACITY	FINISH	AVAILABLE COLORS
PRGS-455	23.75" x 6.32"-7.32" x 23.75" (603 x 161-186 x 603mm)	15.5lb (7.03kg)	50lb (22kg)	Powder Coat	White
PRSS-455		15.1lb (6.87kg)			

Package Specifications

	PACKAGE SIZE (W x H x D)	PACKAGE SHIP WEIGHT	PACKAGE UPC CODE	PACKAGE CONTENTS	UNITS IN PACKAGE
PRGS-455	18.50" x 3.63" x 26.25" (470 x 92 x 667mm)	19.6lb (8.91kg)	735029300304	CMJ455, PRGS-UNV, suspension cables, projector mounting hardware and instructions	1
PRSS-455		19.2lb (8.74kg)	735029300311	CMJ455, PRSS-UNV, suspension cables, projector mounting hardware and instructions	

Accessories

AEC and EXT models: Extension columns

All dimensions = inch (mm)

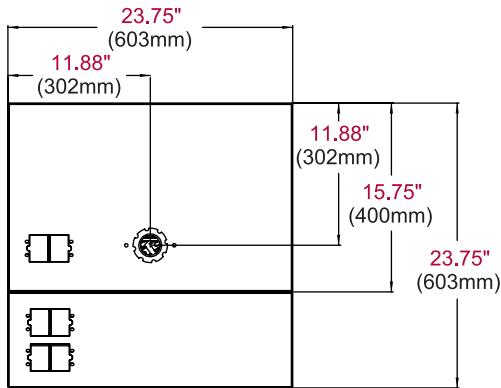

TOP VIEW

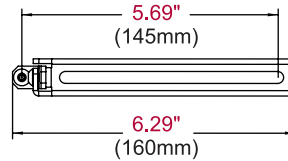

ADAPTOR CHANNEL

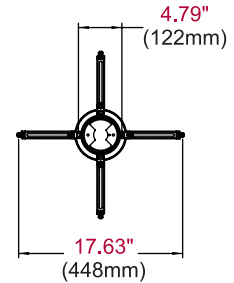

ADAPTOR PLATE

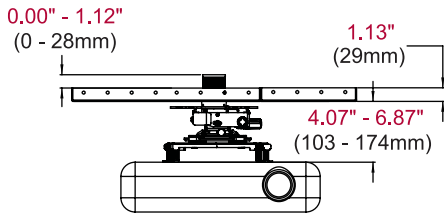

FRONT VIEW

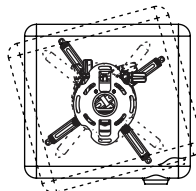

+/- 15° SWIVEL

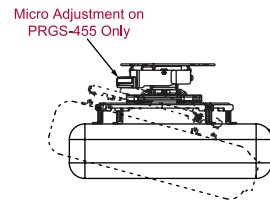

+15/- 20° PITCH

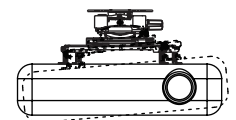

+/- 5° ROLL

ARCHITECTS SPECIFICATIONS

The Projector Mount Kit shall be a Peerless-AV model PRGS-455/PRSS-455 and shall be located where indicated on the plans. Assembly and installation shall be done according to instructions provided by the manufacturer.

Peerless Industries, Inc. ■ 2300 White Oak Circle ■ Aurora, IL 60502 ■ (800) 865-2112 ■ (630) 375-5100 ■ Fax: (800) 359-6500 ■ peerless-av.com

Visit peerless-av.com to see the complete line of AV solutions from Peerless-AV, including flat panel mounts, projector mounts, carts/stands, furniture, cables, screen cleaners and a full assortment of accessories.