

7. Connect the wires (choose A or B)... only after reading other side completely

A: One cable (2 or 3 wires) entering the box

OR

B: Two cables (4 or 6 wires) entering the box

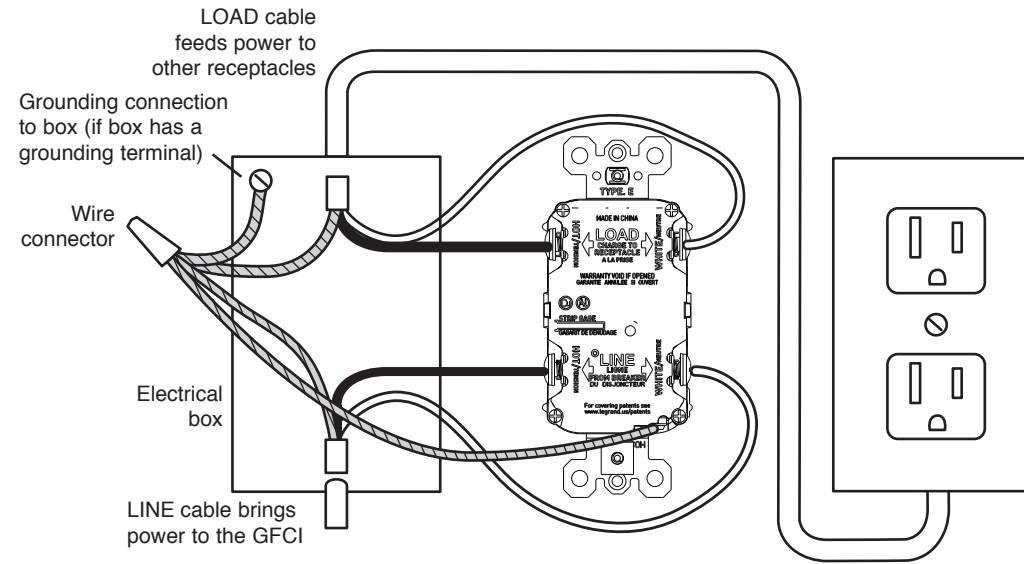
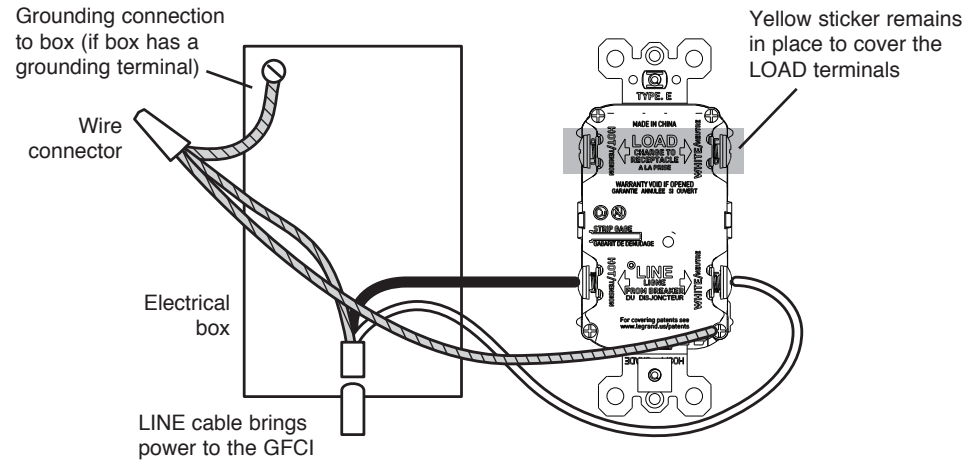

About wire connections:

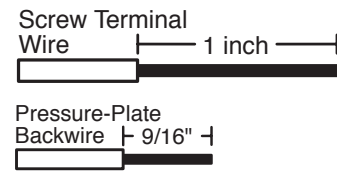

Side Wire
Clockwise,
2/3 of the way
around screw

Pressure-Plate Back Wire

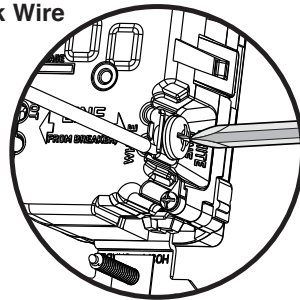

Connect the LINE cable wires to the LINE terminals:

- The white wire connects to the White terminal (Silver)
- The black wire connects to the Hot terminal (Brass)

Connect the grounding wire (only if there is a grounding wire):

- For a box with no grounding terminal (diagram not shown): Connect the LINE cable's bare copper (or green) wire directly to the grounding terminal on the GFCI receptacle.
- For a box with a grounding terminal (diagram shown above): Connect a 6-inch bare copper (or green) 12 or 14 AWG wire to the grounding terminal on the GFCI. Also connect a similar wire to the grounding terminal on the box. Connect the ends of these wires to the LINE cable's bare copper (or green) wire using a wire connector. If these wires are already in place, check the connections. Torque terminal screws to 14-16 inch-pounds.

Complete the installation:

- Fold the wires into the box, keeping the grounding wire away from the White and Hot terminals. Screw the receptacle to the box and attach the faceplate.
- Go to step 8.

About wire connections:

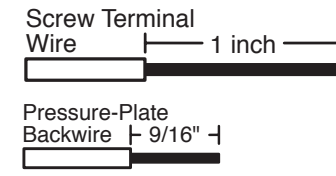

Side Wire
Clockwise,
2/3 of the way
around screw

Pressure-Plate Back Wire

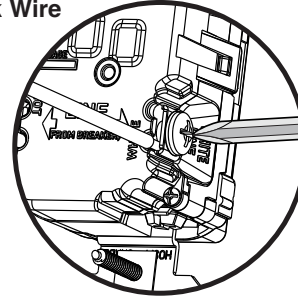

Connect the LINE cable wires to the LINE terminals:

- The white wire connects to the White terminal (Silver)
- The black wire connects to the Hot terminal (Brass)

Connect the LOAD cable wires to the LOAD terminals:

- Remove the yellow sticker to reveal the LOAD terminals
- The white wire connects to the White terminal (Silver)
- The black wire connects to the Hot terminal (Brass)

Connect the grounding wires as shown above (only if there is a grounding wire):

- Connect a 6-inch bare copper (or green) 12 or 14 AWG wire to the grounding terminal on the GFCI. If the box has a grounding terminal, also connect a similar wire to the grounding terminal on the box. Connect the ends of these wires to the LINE and LOAD cable's bare copper (or green) wire using a wire connector. If these wires are already in place, check the connections. Torque terminal screws to 14-16 inch-pounds.

Complete the installation:

- Fold the wires into the box, keeping the grounding wire away from the White and Hot terminals. Screw the receptacle to the box and attach the faceplate.
- Go to step 8.

NOTE: Outlets are not intended to support devices or appliances. Do not hang devices by charging cord.

8. Test your work

Why perform this test?

- If you miswired the GFCI, it may not prevent personal injury or death due to a ground fault (electrical shock).

Procedure:

- Turn the power ON at the service panel. Press the RESET button fully. The RESET button should stay in. If the RESET button does not stay in, go to Troubleshooting. If the RESET button stays in, plug a lamp or radio into the GFCI (and leave it plugged in) to verify that the power is ON. If there is no power, go to Troubleshooting.
- Press the TEST button in order to trip the device. This should stop the flow of electricity, making the radio or lamp shut OFF and the GFCI's red Indicator Light (if present) come on. Note that the RESET button will pop-out. If the power stays ON, or the red Indicator Light stays off, go to Troubleshooting. If the power goes OFF, and the red Indicator Light comes on, you have installed the GFCI receptacle correctly. To restore power, press the RESET button.
- If you installed your GFCI using step 7B, plug a lamp or radio into surrounding receptacles to see which one(s), in addition to the GFCI, lost power when you pressed the TEST button. Do not plug life saving devices into any receptacles that lost power. Place a "GFCI Protected" sticker on every receptacle that lost power.
- Press the TEST button (then RESET button) every month to assure proper operation.
- This is a **Self-Test GFCI Receptacle with SafeLock Protection™**; it conducts an automatic test every three seconds, ensuring it's always ready to protect. If the device fails the test, the indicator light flashes to signal that the GFCI should be replaced. It also has our proven SafeLock Protection feature: if critical components are damaged and protection is lost, power to this receptacle, and any downstream receptacles, will be disconnected.

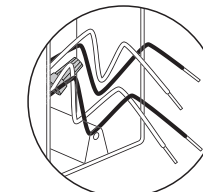
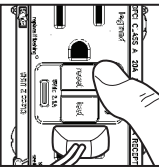
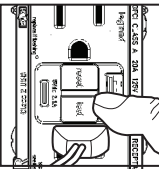
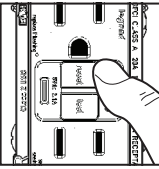

INSTALL TIP

- Pre-fold wires into wall box to make it easier to fit them in the box when outlet is connected.

TROUBLESHOOTING

Turn the power OFF and check the wire connections against the appropriate wiring diagram in step 7A or 7B. Make sure that there are no loose wires or loose connections. Also, it is possible that you reversed the LINE and LOAD connections. LINE/LOAD reversal will be indicated by no power at the GFCI and by the RESET button not staying in when pressed, or by the red Indicator Light remaining off after you press the GFCI's TEST button. Reverse the LINE and LOAD connections if necessary. Start the test from the beginning of step 8 if you rewired any connections to the GFCI.

Ratings:
15A 125V 60Hz
20A 125V 60Hz
USB - 2.1A
at 5V DC

LIMITED ONE YEAR WARRANTY

Pass & Seymour will remedy any defect in workmanship or material in Pass & Seymour products which may develop under proper and normal use within one year from date of purchase by a consumer:
(1) by repair or replacement, or, at Pass & Seymour's option, (2) by return of an amount equal to consumer's purchase price. Such remedy is IN LIEU OF ANY AND ALL EXPRESSED OR IMPLIED WARRANTIES OF MERCHANTABILITY OR FITNESS FOR A PARTICULAR PURPOSE. Such remedy by Pass & Seymour does not include or cover cost of labor for removal or reinstallation of the product. ALL OTHER FURTHER ELEMENTS OF DAMAGE (INCIDENTAL OR CONSEQUENTIAL DAMAGES) FOR BREACH OF ANY AND ALL EXPRESSED OR IMPLIED WARRANTIES INCLUDING WARRANTIES OF MERCHANTABILITY OR FITNESS FOR A PARTICULAR PURPOSE ARE EXCLUDED HEREBY. (Some states do not allow disclaimers or exclusion or limitation of incidental or consequential damages, so the above disclaimer and limitation or exclusion may not apply to you.) ANY IMPLIED WARRANTIES INCLUDING WHERE REQUIRED WARRANTIES OF MERCHANTABILITY OR FITNESS FOR A PARTICULAR PURPOSE SHALL BE LIMITED TO THE ONE YEAR PERIOD SET FORTH ABOVE. (Some states do not allow limitations on how long an implied warranty lasts, so the above limitation may not apply to you.)

To insure safety, all repairs to Pass & Seymour products must be made by Pass & Seymour, or under its specific direction. Procedure to obtain performance of any warranty obligation is as follows: (1) Contact Pass & Seymour, Syracuse, New York 13221, for instructions concerning return or repair; (2) return the product to Pass & Seymour, postage paid, with your name and address and a written description of the installation or use of the Pass & Seymour product, and the observed defects or failure to operate, or other claimed basis for dissatisfaction.

This warranty gives you specific legal rights and you may also have other rights which vary from state to state.



Pass & Seymour

P.O. Box 4822 (800) 223-4185
Syracuse, NY 13221 www.legrand.us
For covering patents, see www.legrand.us/patents
N° 341325 10/20

Installing and Testing a GFCI Receptacle with 2 USB ports

For help meeting NEC guidelines, please visit www.legrand.us/gfci

Please read this leaflet completely before getting started.

CAUTION

- To prevent severe shock or electrocution, always turn the power OFF at the service panel before working with wiring.
- Use this GFCI receptacle with copper or copper-clad wire. Do not use it with aluminum wire.
- Do not install this GFCI receptacle on a circuit that powers life support equipment because if the GFCI trips, it will shut down the equipment.
- For installation in damp or wet locations, the GFCI receptacle must be Listed and marked as Weather Resistant (WR).
- For installation in wet locations, protect the GFCI receptacle with a weatherproof cover that will keep both the receptacle and any plugs dry.
- Outlets are not intended to support devices or appliances. Do not hang devices by charging cord.
- All cables should be routed away from the outlet openings.
- Must be installed in accordance with national and local electrical codes.

MISE EN GARDE

- Pour éviter toute décharge grave ou électrocution, éteignez toujours l'alimentation sur le panneau de service avant de travailler sur le câblage.
- Utilisez cette prise DDFT avec des fils en cuivre ou revêtus de cuivre. Ne l'utilisez pas avec des fils en aluminium.
- Ne montez pas cette prise DDFT sur un circuit qui alimente un équipement de maintien en vie car, s'il se déclenche, il éteindra l'équipement.
- En cas d'installation dans un lieu humide, la prise DDFT doit être homologuée et marquée comme étant à l'épreuve des intempéries.
- Pour une installation dans des endroits humides, recouvrez la prise DDFT d'une protection étanche qui maintiendra la prise et tous les branchements au sec.
- Les prises ne sont pas conçues pour prendre en charge des appareils ou des appareils. Ne suspendez pas les appareils par le cordon de charge.
- Tous les câbles doivent être acheminés loin des ouvertures de sortie.
- Ce dispositif doit être installé conformément aux réglementations nationales et locales relatives à l'électricité.

1. What is a GFCI?

A GFCI receptacle is different from conventional receptacles. In the event of a ground fault, a GFCI will trip and quickly stop the flow of electricity to prevent serious injury.

Definition of a ground fault: Instead of following its normal safe path, electricity passes through a person's body to reach the ground. For example, a defective appliance can cause a ground fault. A GFCI receptacle does not protect against circuit overloads, short circuits, or shocks. For example, you can still be shocked if you touch bare wires while standing on a non-conducting surface such as a wood floor.

Self-Test GFCI Receptacle with SafeLock Protection

This is a **Self-Test GFCI Receptacle with SafeLock™ Protection**; it conducts an automatic test every three seconds, ensuring it's always ready to protect. If the device fails the test, the indicator light flashes to signal that the GFCI should be

replaced. It also has our proven SafeLock Protection feature: if critical components are damaged and protection is lost, power to this receptacle, and any downstream receptacles, will be disconnected.

2. The GFCI's features

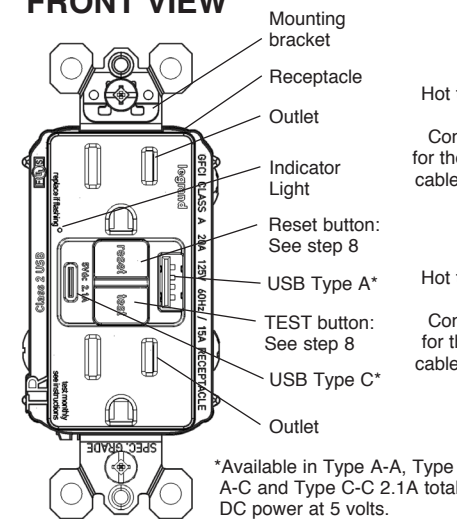

Screw (terminal) colors:
Green = grounding terminals
Silver = white terminals
Brass = hot terminals

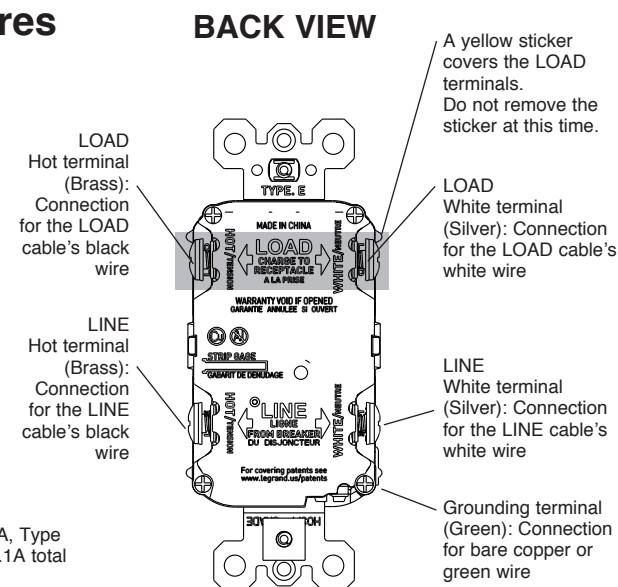

3. Should you install it?

Installing a GFCI receptacle can be more complicated than installing a conventional receptacle.

Make sure that you:

- Understand basic wiring principles and techniques.
- Can interpret wiring diagrams.
- Have circuit wiring experience.
- Are prepared to take a few minutes to test your work, making sure that you have wired the GFCI receptacle correctly.

4. LINE vs. LOAD

A cable consists of 2 or 3 wires.

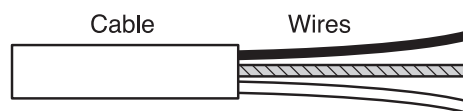

LINE cable:

Delivers power from the service panel (breaker panel or fuse box) to the GFCI. If there is only one cable entering the electrical box, it is the LINE cable. This cable should be connected to the GFCI's LINE terminals only.

LOAD cable:

Delivers power from the GFCI to another receptacle in the circuit. This cable should be connected to the GFCI's LOAD terminals only. The LOAD terminals are under the yellow sticker. Do not remove the sticker at this time.

5. Turn the power OFF

Plug an electrical device, such as a lamp or radio, into the receptacle on which you are working. Turn the lamp or radio on. Then, go to the service panel. Find the breaker or fuse that protects that receptacle. Place the breaker in the OFF position or completely remove the fuse. The lamp or radio should turn OFF.

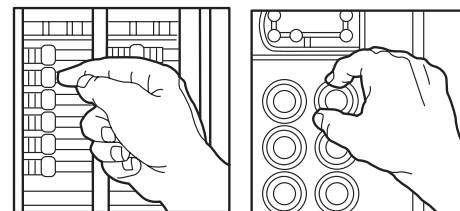

Next, plug in and turn ON the lamp or radio at the receptacle's other outlet to make sure the power is OFF at both outlets. If the power is not OFF, stop work and call an electrician to complete the installation.

6. Identify cables/wires

IMPORTANT:

Do not install the GFCI receptacle in an electrical box containing (a) more than 4 wires (not including the grounding wires) or (b) cables with more than two wires (not including the grounding wire). Contact a qualified electrician if either (a) or (b) is true.

- If you are replacing an old receptacle, pull it out of the electrical box without disconnecting the wires.
- If you see one cable (2-3 wires), it is the LINE cable. The receptacle is probably in position C (see diagram to the right). Remove the receptacle and go to step 7A.
- If you see two cables (4-6 wires), the receptacle is probably in position A or B (see diagram to the right). Follow steps a-e of the procedure to the right.

Procedure: box with two cables (4-6 wires)

- Detach one cable's white and hot wires from the receptacle and cap each one separately with a wire connector. Make sure that they are from the same cable.
- Re-install the receptacle in the electrical box, attach the faceplate, then turn the power ON at the service panel.
- Determine if power is flowing to the receptacle. If so, the capped wires are the LOAD wires. If not, the capped wires are the LINE wires.
- Turn the power OFF at the service panel, label the LINE and LOAD wires, then remove the receptacle.
- Go to step 7B.

Placement in circuit:

The GFCI's place in the circuit determines if it protects other receptacles in the circuit.

Sample circuit:

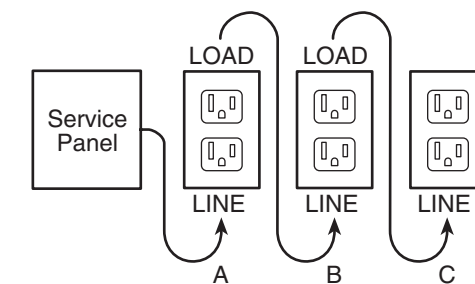

Placing the GFCI in position A will also provide protection to "load side" receptacles B and C. On the other hand, placing the GFCI in position C will not provide protection to receptacles A or B. Remember that receptacles A, B, and C can be in different rooms.