



## QUICK START GUIDE



MODEL: S48-APOE

## Before You Begin

Create your free Alta account to manage your Alta devices. Visit **manage.alta.inc** or download the **Alta Networks** app.

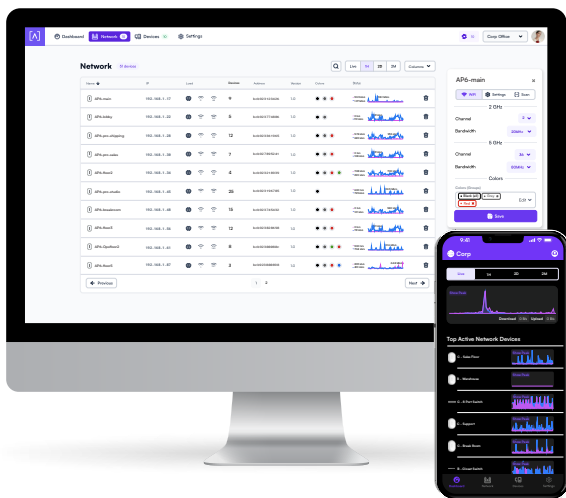

# Package Contents



S48-APOE



Rack Ears  
(Qty. 2)



Rack Ear Screws  
(M4x8.5mm, Qty. 8)



Rackstud™ DUO  
Studs (Qty. 2)



Rackstud DUO  
Nuts (Qty. 4)



SFP+ Port Plugs  
(Qty. 4)



Power Cord



**Note:** We recommend using the included mounting hardware for product installation.

## Installation Requirements

- Ethernet cabling (CAT 5e or above)
- Phillips screwdriver

# Hardware Overview

## Front



## Alta Labs LED

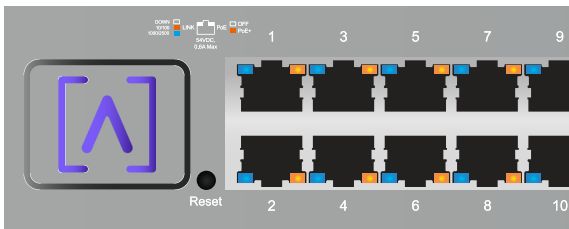

The Alta Labs LED flashes as the unit is powered up. Once fully booted, the LED will remain lit unless turned off in the UI. The LED color can also be changed in the management interface.

## Ports and LEDs

ALL 48 ports on the S48-APOE support 802.3at PoE+ with up to 30W per port and a PoE budget of 740 Watts.

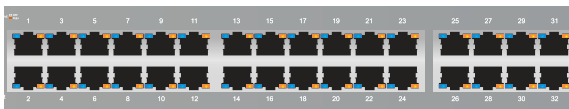

Ports 1-32 are standard Gigabit Ethernet ports that support 10/100/1000 Mbps connections.

The **Link** LED on the left indicates a 10/100 Mbps connection when amber, blue indicates a 1 Gbps connection, and if not illuminated, the connection is down.

The **PoE** LED on the right will illuminate amber when a device connected to the port is being powered via Ethernet.

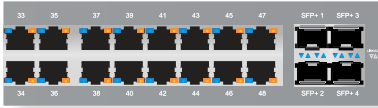

Ports 33-48 are 2.5 Gigabit Ethernet ports that support 10/100/1000/2500 Mbps connections.

The **Link** LED on the left indicates a 10/100 Mbps connection when amber, blue indicates a 1 Gbps or 2.5 Gbps connection, and if not illuminated, the connection is down.

The **PoE** LED on the right will illuminate amber when a device connected to the port is being powered via Ethernet.



The SFP+ Ports support fiber optic and Ethernet transceivers with 1 Gbps, 2.5 Gbps, 5 Gbps, or 10 Gbps connections.

The **Link** LED on the left will illuminate blue when there is a 1 Gbps, 2.5 Gbps, or 5 Gbps connection, it will illuminate white with a 10 Gbps connection.

The **Activity** LED on the right flashes blue when there is activity on a 1 Gbps, 2.5 Gbps, or 5 Gbps connection. It will flash white if there is 10 Gbps network activity.

## Back



Cooling fan vents are located on the back of the switch. Be sure to use the included power cord to connect power.

## Sides



Left Side



Right Side

The side panels feature cooling vents.

# Hardware Installation

## Rackmount

1. Determine how you want the switch positioned within the rack.

Most users will want the front of the switch flush with the rack, to do so, align the Rack Ears so they utilize the 3 holes shown below:



Some users may want the switch to protrude from the rack. If this is your preference, align the 4 holes as shown below:



2. Connect the two Rack Ears to both sides of the switch using the eight Rack Ear Screws.

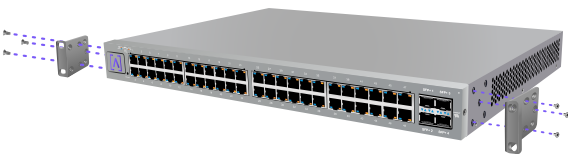

3. Ensure the arrow on the back of the Rackstud DUO stud is pointing up.

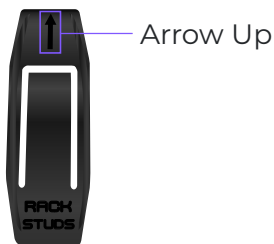

4. Insert the Rackstud DUO stud at the beginning of the RU space just below the thin area.

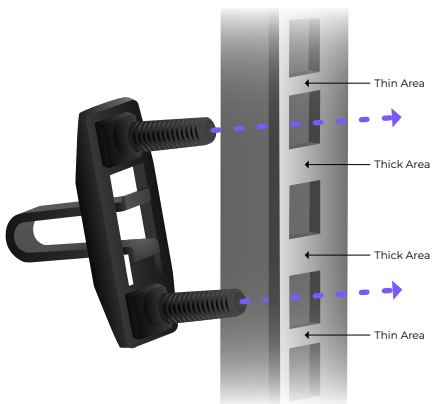

5. Compress the spring and insert the Rackstud DUO stud from behind the rail.

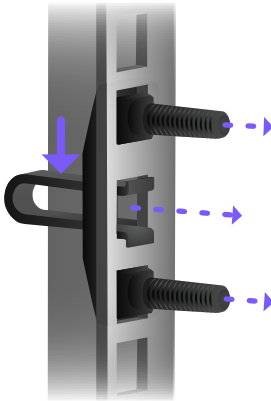

6. Repeat the same procedure on the opposite rail on the rack.

7. Slide the switch over the Rackstud DUO stud and apply pressure to the front face while installing the Rackstud DUO nuts to the bottom on both sides of the switch.

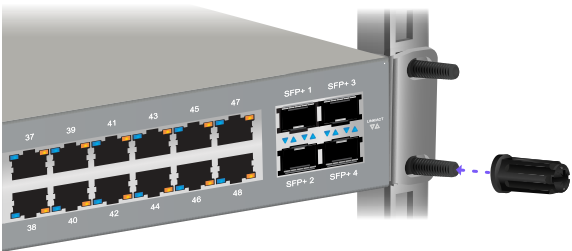

8. Connect the top Rackstud DUO nuts on both sides of the switch.

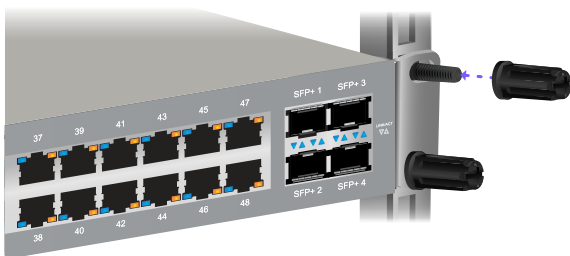

## Mounting On A Wall

1. Connect the two Rack Ears to both sides of the switch using the eight Rack Ear Screws. Be sure to orient the Rack Ears so the openings face the wall.

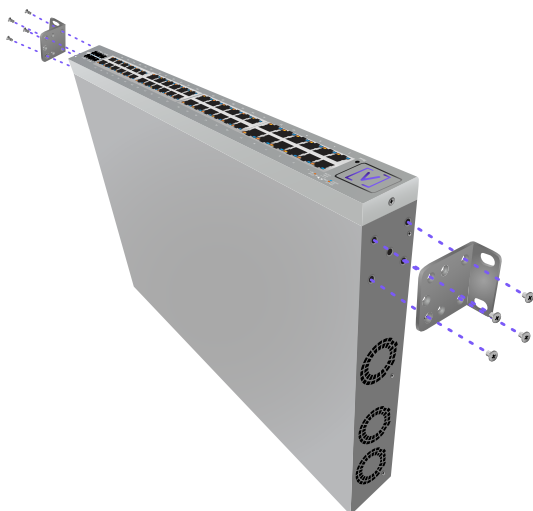

2. Use wall screws and anchors (not included) to secure both sides of the switch to the wall.

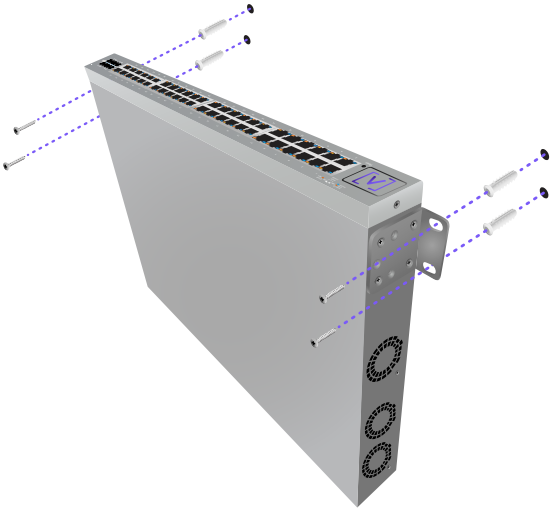

## Connecting Devices

1. All 48 ports support Power over Ethernet. The ports are autosensing. Ports 1-32 can support devices that connect at speeds up to 1 Gbps. Ports 33-48 support devices that connect at up to 2.5 Gbps.

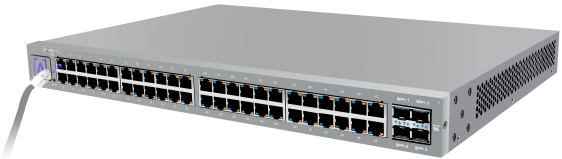

2. Follow the instructions included with your transceivers to connect them to the SFP+ ports. If not using the ports, be sure to use the SFP+ Port Plugs over the ports.

## Set Up Your Device

1. Follow the instructions in the Alta app or management interface to set up your switch.

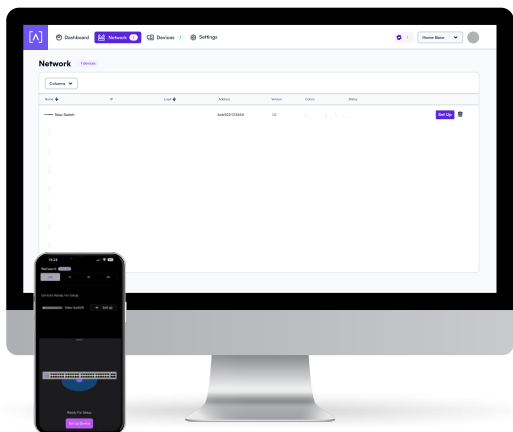

## S48-APOE Specifications

Mechanical	
Dimensions	440 x 310 x 44 mm (17.32 x 12.20 x 1.73")
Weight	4.99 kg (11 lbs)
Material Type	SGCC
Material Finish	Powder coat - Matte
Color	Metalic gray

Ports	
Interface ports	(32) 10/100/1000 Mbps, (16) 10/100/1000/2500 Mbps
SFP/SFP+	(4) SFP+
Switching Capacity	240 Gbps
Non-blocking Throughput	120 Gbps
Forwarding Rate	178.6 Gbps
PoE Budget/Max	740 Watts
PoE Supply	30 Watts per port
Per Port PoE	(48) 802.3at PoE+
Non-PoE Ports	None

LEDs	
PoE	Orange
Network	Orange: 10/100, Blue: 1000/2500 Gbps
SFP/SFP+	Blue: 1 Gbps White: 10 Gbps

Hardware	
Packet Buffer	16 Mbit
Mac Table Size	32K
Energy Efficient Ethernet	Yes
Management	Factory reset button
Band	2.4 GHz (For Bluetooth Setup)
Bluetooth Version	BLE
Total Power	6 dBm EIRP
Gain	2 dBi

Power	
Idle Power Consumption	15 Watts
Max Power Consumption w/o PoE	68 Watts
Max Power Consumption Full PoE	890 Watts
Output	PoE+, 54VDC, 0.6A Max.
Power Supply	Universal AC, 100 - 240VAC 50-60Hz Internal
RJ45 Port Surge Protection	12kV for ESD - contact, 25kV for ESD - Air

Environmental	
Mounting	Rackmount, Wallmount
Operating Temperature	-5 to 50° C (23 to 122° F)
Operating Humidity	10 to 90% Noncondensing
IP Rating	None
EMI Rating	Class A with 3 dB Margin
Cooling Fan	Yes
Certifications	CE, FCC, IC

# Compliance

## Federal Communication Commission Interference Statement

This product has been tested and found to comply with the limits for a Class A digital device pursuant to Part 15 of the FCC Rules. These limits are designed to provide reasonable protection against harmful interference when the equipment is operated in a commercial environment. This equipment generates, uses, and can radiate radio frequency energy and, if not installed and used in accordance with the instruction manual, may cause harmful interference to radio communications. Operations of this equipment in a residential area is likely to cause harmful interference in which case the user will be required to correct the interference at his own expense.

However, there is no guarantee that interference will not occur in a particular installation. If this equipment does cause harmful interference to radio or television reception, which can be determined by turning the equipment off and on, the user is encouraged to try to correct the interference by one or more of the following measures:

- Reorient or relocate the receiving antenna.
- Increase the separation between the equipment and receiver.
- Connect the equipment into an outlet on a circuit different from that to which the receiver is connected.
- Consult the dealer or an experienced radio/TV technician for help.

### FCC Caution

This device complies with Part 15 of the FCC Rules.

Operation is subject to the following two conditions:

- (1) This device may not cause harmful interference, and
- (2) This device must accept any interference received, including interference that may cause undesired operation.

This device is restricted to indoor use.

### Non-Modification Statement

Changes or modifications not expressly approved by the party responsible for compliance could void the user's authority to operate the equipment.

## **FCC Radiation Statement**

This equipment complies with FCC radiation exposure limits set forth for an uncontrolled environment. This equipment should be installed and operated with minimum distance 20cm between the radiator and your body.

## **CAN ICES-003(A) / NMB-003(A)**

This device contains licence-exempt transmitter(s)/ receiver(s) that comply with Innovation, Science and Economic Development Canada's licence-exempt RSS(s). Operation is subject to the following two conditions:

- (1) This device may not cause interference.
- (2) This device must accept any interference, including interference that may cause undesired operation of the device.

L'émetteur/récepteur exempt de licence contenu dans le présent appareil est conforme aux CNR d'Innovation, Sciences et Développement économique Canada applicables aux appareils radio exempts de licence.

L'exploitation est autorisée aux deux conditions suivantes :

- (1) L'appareil ne doit pas produire de brouillage;
- (2) L'appareil doit accepter tout brouillage radioélectrique subi, même si le brouillage est susceptible d'en compromettre le fonctionnement.

## **ISED Radiation Exposure Statement:**

This equipment complies with IC RSS-102 radiation exposure limits set forth for an uncontrolled environment. This equipment should be installed and operated with minimum distance 20cm between the radiator & your body.

Cet équipement est conforme aux limites d'exposition aux rayonnements IC établies pour un environnement non contrôlé. Cet équipement doit être installé et utilisé avec un minimum de 20cm de distance entre la source de rayonnement et votre corps.

The transmitter module may not be co-located with any other transmitter or antenna.

Le module émetteur peut ne pas être coïmplanté avec un autre émetteur ou antenne.

## **Laser Warning**

- Do not open or disassemble any laser
- Do not look directly at the ends of fiber optic transceivers or fiber optic cables; radiation generated by transmitting lasers, transceivers, and fiber optic cables may damage your eyes
- Please be careful when installing fiber optic transceiver to avoid damaging the fiber optic transceiver
- Laser Class I (fiber optic transceiver) should be used



**ALTA**  
LABS

## **Community Forum**

 [forum.alta.inc](https://forum.alta.inc)

## **Technical Support**

 [help.alta.inc](https://help.alta.inc)

All specifications are subject to change without notice.  
Alta Labs products are sold with a limited warranty:  
[alta.inc/warranty](https://alta.inc/warranty)

© 2025 Alta Networks, LLC. All rights reserved.  
Alta Labs is a trademark of Alta Networks, LLC.