

DESCRIPTION

The H7 recessed housing is the standard in the industry for both commercial and residential applications. The wide variety of trims available allows a number of different lighting effects to be created with one basic housing.

APPLICATION

The H7T is a suited for use in non-insulated ceilings in residential and commercial applications. If ceiling insulation is present, it must be kept 3" from the fixtures on all sides.

DESIGN FEATURES

A...Housing

Die-stamped 20 gauge CRS with white powder coat finish.

B...Socket Plate

Rigid socket plate adjusts and locks without tools for various lamp sizes.

C...Plaster Frame

Housing adjusts in plaster frame 1 3/8" to accommodate different ceiling thicknesses. Plaster frame features include:

- Regressed locking screw for securing hanger bars
- Cutouts for easily crimping hanger bars in position
- Halo name embossed on plaster frame Galvanized steel construction. The housing can be removed from plaster frame to provide access to the junction box.

D...Junction Box

- Junction box features include:
- UL listed for through branch circuit wiring

- Positioned to accommodate straight conduit runs
- Seven 1/2" trade size conduit knockouts with true pry-out slots
- Slide-N-Side™ connectors allow 14/2 or 12/2 non-metallic sheathed cable to be installed without tools and without removing knockouts

E...GOT NAIL! Pass-N-Thru™ Bar Hangers

Bar Hanger Features include:

- Pre-installed nail easily installs in regular lumber, engineered lumber and laminated beams
- Safety and guidance system prevents snagging, ensures smooth straight nail penetration and allows bar hangers to be easily removed if necessary.
- Automatic levelling flange aligns the housing and lets you hold the housing in place with one hand while driving nails
- Housing can be positioned at

- any point within 24" joist span
- Score lines allow "toolless" shortening for 12" joists
- Bar hangers may be repositioned 90°
- Bar hangers do not need to be removed from frame for shortening
- Integral T-bar clips snaps onto T-bars - no additional clips required

F...Socket

Porcelain socket with nickel plated brass screw shell.

G...Thermal Protector

Self resetting thermal protector deactivates fixture if overheating occurs due to improper lamping or misapplied insulation.

Labels

- UL Listed for Damp Location
- UL listed for Feed Through
- CSA Certified
- IP Rated

Catalog #	Type
Project	
Comments	
Prepared by	Date

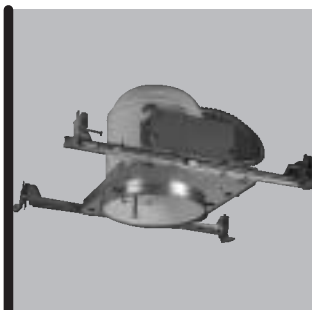

H7T

6" Non-Insulated Ceiling Recessed Housing

6" TRIMS

FOR USE IN NON-INSULATED CEILINGS OR INSULATED CEILINGS BUT INSULATION MUST BE KEPT 3" FROM ALL SIDES OF FIXTURE

This housing is AIR-TITE when used with the following Trims:

- 170PS
- 171PS
- 173PS
- 78PAT
- 30 (All Styles)
- 430 (All Styles)

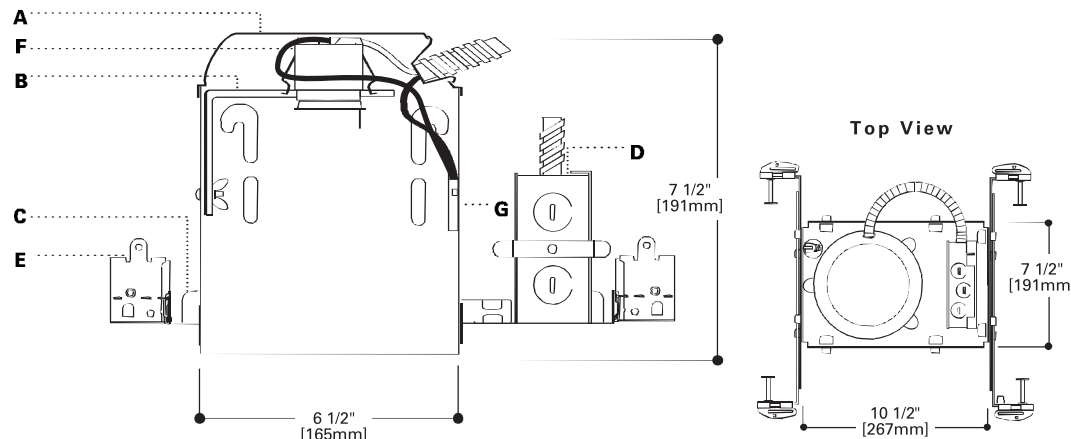

ORDERING INFORMATION SAMPLE NUMBER: H7T-426RG

Order housing, trim and accessories separately.

Housing	Trims	Accessories
H7T		
Non-Insulated Ceiling Housing	See reverse side	<p>Metal Trim Rings Compatible with 310, 376, 378, 410, 419, 420, 424, 425, 426, 1412, 1416, 1475 TRM6P=White Metal TRM6PB=Polished Brass TRM6C=Chrome TRM6MB=Black Metal TRM6SL=Silver Metal TRP7MB=Black Plastic</p> <p>Oversize Trim Rings For use when ceiling opening is cut too large. Compatible with 310, 376, 378, 405, 410, 419, 420, 424, 425, 426, 429, 1412, 1416, 1475 OT400P=9 1/4" White Metal OT403P= 8" White Plastic</p> <p>Step Down Transformer Steps 277V line voltage down to 120V fixture operating voltage. 150VA max. H277=150VA Max.</p>

UPGRADE FEATURES:

- SLIDE-N-SIDE™ JUNCTION BOX
- GOT NAIL!™ BAR HANGERS
- PASS-N-THRU™ BAR HANGERS
- REGRESSED LOCKING SCREW
- HALO ID ON PLASTER FRAME

ADV042492

Supersedes ADV031586, ADV023109 & ADV000304
9/04

TAB: Recessed Incandescent Sheet 23

Trims

REFLECTORS

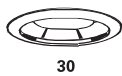

30



30



405



426



429



4051



4261

BAFFLES

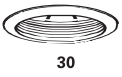

30

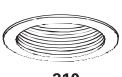

310



410

ADJUSTABLES



74

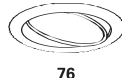

76



77



78



90

AIR-TITE Super Trim
150W A21, 150W PAR38, 100W R30,
75W PAR30, 75W PAR30L, 65W BR30
30CAT=Specular Clear, Air-Tite
30HAT=Haze, Air-Tite
30RGAT=Residential Gold, Air-Tite
OD: 7 1/4" (184mm)

AIR-TITE Super Trim
50W PAR30, 75W PAR30L, 100W R30,
85W BR30, 150W R40, 120W BR40,
100W A19, 150W PAR38, 150W A21
30SBAT=Specular Black, Air-Tite
OD: 7 1/4" (184mm)

Specular Reflector
150W A21
405SC=Specular Clear
405H=Haze
405RG=Residential Gold
405CG=Champagne Gold
OD: 7 1/4" (184mm)

Specular Reflector Cone
75W R30, 65W BR30, 75W PAR30,
150W R40, 150W PAR38
426=Specular Clear
426H=Haze
426RG=Residential Gold
426CG=Champagne Gold
426MB=Specular Black
OD: 7 1/4" (184mm)

Dayform Cone
75W R30, 65W BR30
429P=White
OD: 7 1/4" (184mm)

Self Flanged Reflector
150W A21
4051P=White
OD: 7 1/4" (184mm)

Self Flanged Reflector Cone
75W R30, 65W BR30, 75W PAR30,
150W R40, 150W PAR38
4261P=White
OD: 7 1/4" (184mm)

AIR-TITE Super Trim
100W A19, 150W PAR38, 100W R30,
75W PAR30, 65W BR30, 75W PAR30L
30PAT=Black Baffle
30WAT=White Baffle
OD: 7 1/4" (184mm)

Baffle
75W R30, 65W BR30, 75W PAR30
310P=Black Baffle
310W=White Baffle
OD: 7 1/4" (184mm)

Baffle
150W PAR38, 150W R40
410P=Black Baffle
410W=White Baffle
OD: 7 1/4" (184mm)

Eyeball - 30° Tilt
75W PAR30
74P=White Eyeball
OD: 8" (203mm)

Adjustable - 30° Tilt
150W PAR38 Side Prong
76P=White Eyeball
OD: 8" (203mm)

Eyeball
50W R20, 50W PAR20
77P=White Eyeball
OD: 8" (203mm)

Eyeball - 30° Tilt
75W R30, 65W BR30, 75W PAR30L
78P=White Eyeball
78SL=Silver
78B=Brass Eyeball
78PB=Polished Brass Eyeball
78PAT=Polished Brass Eyeball (converts
H7T to AIR-TITE Construction)
OD: 8" (203mm)

Adjustable - 60° Tilt
250W PAR38
90P=White "Double Bubble"
OD: 8" (203mm)



376



378

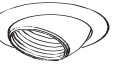

417



419



420



478

DIFFUSERS

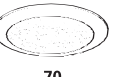

70



71

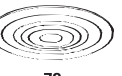

73

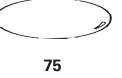

75



416



172

OPEN



79



301



328

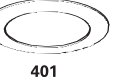

401



428

Adjustable
75W PAR30
376P=Black Baffle, White Trim Ring
OD: 7 1/4" (184mm)

Adjustable with Splay Reflector
75W PAR30
378=White w/ Specular Clear Splay Reflector
378P=White w/ White Splay Reflector
OD: 7 1/4" (184mm)

Coilex Baffle Eyeball
75W PAR30
417P=White with Black Baffle
417PB=Brass with Black Baffle
417W=Brass with White Baffle
OD: 8" (203mm)

Regressed Eyeball
75W PAR30
419=White w/ Specular Clear Splay Reflector
419P=White w/ White Splay Reflector
OD: 8" (203mm)

Coilex Regressed Eyeball
75W BR30, 75W PAR30L
420P=Black Baffle, White Eyeball
420PB=Black Baffle, Polished Brass
Eyeball
420W=White Baffle, White Eyeball
OD: 7 1/4" (184mm)

Adjustable with Splay - 25° Tilt
90W PAR38
478=White w/ Specular Clear Splay Reflector
478P=White w/ White Splay Reflector
OD: 7 1/4" (184mm)

Glass Albalite Lens
60W A19
70P=White Trim Ring
70PS=White Trim Ring, Shower Light
OD: 8" (203mm)

Plastic Drop Opal
60W A19
71P=White Trim Ring
71PS=White Trim Ring, Shower Light
OD: 8" (203mm)

Glass Fresnel Lens
60W A19
73P=White Trim Ring
73PS=White Trim Ring, Shower Light
OD: 8" (203mm)

All-Glas Diffuser
60W A19
75=All Glass Diffuser
OD: 7 3/4" (197mm)

Coilex with Semi-Regressed Drop Opal
60W A19
416P=Black Baffle
416W=Black Baffle
OD: 7 1/4" (184mm)

Shower Light
100W A19, 75W PAR30
172PS=White Trim Ring, Shower Light
OD: 7 3/4" (197mm)

Pinhole Trim
50W R20
79P=White
OD: 8" (203mm)

Open
75W R30, 75W PAR30, 65W BR30
301P=White Open
301PB=Brass Open
OD: 7 1/4" (184mm)

Splay Trim
75W R30, 75W PAR30, 65W BR30
328P=White Splay
OD: 7 1/4" (184mm)

Open
75W R30, 65W BR30, 75W PAR30
401P=White Open
401AL=Aluminum Open
401PB=Polished Brass Open
OD: 8" (203mm)

Splay Trim
150W R40
428P=White Splay
OD: 7 1/4" (184mm)

WALL WASH



303



424



425

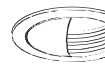

430

LOW VOLTAGE



1412



1416

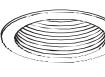

1416BA



1417



1450



1475

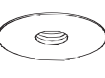

1479

Wall Wash
60W A19
303P=White Wall Wash
OD: 8" (203mm)

Wall Wash
100W A19
424P=White Wall Wash
OD: 7 1/4" (184mm)

Coilex Wall Wash
60W A19
425P=White Wall Wash w/ Black
Baffle
425W=White Wall Wash w/ White
Baffle
OD: 7 1/4" (184mm)

Baffle Wall Wash
40W A19
430P=Black Baffle, White Scoop,
White Trim Ring
430W=White Baffle, White Scoop,
White Trim Ring
OD: 7 1/4" (184mm)

Adjustable Spot - 30° tilt (Includes
12V transformer for retrofit)
50W 12V MR16

1412P=Black Baffle, Black Spot,
White Trim Ring
1412W=White Baffle, White Spot,
White Trim Ring
OD: 7 1/4" (184mm)

Specular Reflector - 30° tilt (Includes
12V transformer for retrofit)
50W 12V MR16
1416C=Clear Specular Reflector
1416CG=Champagne Gold Specular
Reflector
OD: 7 1/4" (184mm)

Baffle - 30° tilt (Includes 12V
transformer for retrofit)
50W 12V MR16
1416BA=Black Baffle, White Trim
Ring
1416W=White Baffle, White Trim
Ring
OD: 7 1/4" (184mm)

Coilex Baffle Eyeball - 30° tilt
(Includes 12V transformer for
retrofit)
50W 12V MR16
1417P=White Eyeball, Black
Baffle, White
Trim Ring
1417W=White Eyeball, White
Baffle, White
Trim Ring
OD: 8" (203mm)

Adjustable Slot Aperture 30° tilt
(Includes 12V transformer for
retrofit)
50W 12V MR16
1450P=White
OD: 7 1/4" (184mm)

Adjustable Accent - 30° tilt (Includes
12V transformer for retrofit)
50W 12V PAR36
1475P=White Holder, Black Baffle,
White Trim Ring
1475W=White Holder, White Baffle,
White Trim Ring
OD: 7 1/4" (184mm)

1 7/8" Pinhole Downlight (Includes
12V transformer for retrofit)
50W 12V MR16
1479P=White Trim, Black Baffle
1479W=White Trim, White Baffle
OD: 7 1/4" (184mm)

Note: Specifications and Dimensions subject to change without notice.

Visit our web site at www.cooperlighting.com