

DESCRIPTION

Recessed 4" aperture ultra-shallow new construction housing with integral step down transformer optimized for low voltage LED MR16 lamps. Suitable for 2x4 residential framing or shallow plenum commercial construction, meets restrictive airflow requirements and can be used in direct contact with insulation. Use with compatible Halo™ trims and LED MR16 lamps (by others) providing a broad range of trim styles and optical distributions.

Catalog #		Type
Project		
Comments		Date
Prepared by		

SPECIFICATION FEATURES

Housing

- Single wall deep drawn aluminum housing painted matte black for a visually dark interior
- Adjusts vertically to accommodate 3/8" to 1-1/4" thick ceilings and locks in position with (3) setscrews
- Integral gasket achieves airtight compliance without additional caulk or gaskets
- Shipped with overspray protector installed
- Housing can be removed from below the ceiling for service or splice inspection

Plaster Frame

- Compact galvanized steel plaster frame with integral bar hanger receivers
- Notches facilitate use of guide strings or laser lines for precise positioning
- Regressed screws provide positive horizontal bar hanger locking from below the ceiling
- Perforations accept drywall screws from below securing housing to ceiling structure

Bar Hangers

- Captive preinstalled Got-Nail™ bar hangers supports housing any point along span and tight to framing
- Pass-N-Thru™ feature allows adjust from 6" to 24" wide without removal
- Captive nail penetrates standard and engineered lumber
- Leveling flange aligns plaster frame with structure
- Integral clip attaches directly to tee-bar

Universal Mounting Bracket

Accessory

- Accepts 1/2" EMT, C channel and bar hangers
- Adjusts 3" vertically from above the ceiling
- Installed to plaster frame with (2) screws (provided)

Junction Box

- Compact galvanized steel junction box with 16in3 internal volume
- Listed for (10) #12 AWG 90° C splice conductors
- Repositionable 90° on plaster frame to avoid obstructions
- Hinged door is retained and provides easy access to field wiring
- (6) 1/2" conduit pry-outs positioned to allow straight conduit runs
- (3) Slide-N-Side™ non-metallic (NM) wire traps allows wiring outside the box
- Accepts 14-2, 14-3, 12-2, 12-3 U.S. and 14-2, 14-3, 12-2 Canadian NM cable
- (3) 4-port push wire nuts with clear caps for quick and reliable mains voltage connections

Step Down Transformer

- Low noise toroidal wound magnetic step down transformer
- Thermally protected
- 120/277V 60Hz input provides 12V nominal at 10W output

Socket

- Gx5.3 socket for bi-pin 12V LED MR16 lamps

Trims

- Compatible with a broad range of trim styles and optical distributions
- Friction blades hold trim tight to ceiling surface, gasket minimizes light leaks
- Use with wafer thin, full overlap or die cast flange styles

Compliance

- Type IC suitable for direct contact to air permeable insulation and cULus listed for damp locations
- Not for use in direct contact with spray foam insulation, consult NEMA LSD57-2013
- Wet location listed in covered ceilings and IP44 certified with select lens trims
- Airtight per ASTM-E283
- Can be used for State of California Title 24 high efficacy luminaire compliance with designated trims and CA JA8-2016-E labeled lamps
- Suitable for use in clothes closets when installed in accordance with the NEC 410.16 spacing requirements
- Contains no mercury or lead and RoHS compliant

Warranty

- One year limited warranty, consult website for details.
www.cooperlighting.com



E44MR16ICAT

4" Ultra-Shallow Recessed Low Voltage New Construction Housing

**4" LED MR16 Trims
10W Maximum**



DIMENSIONS

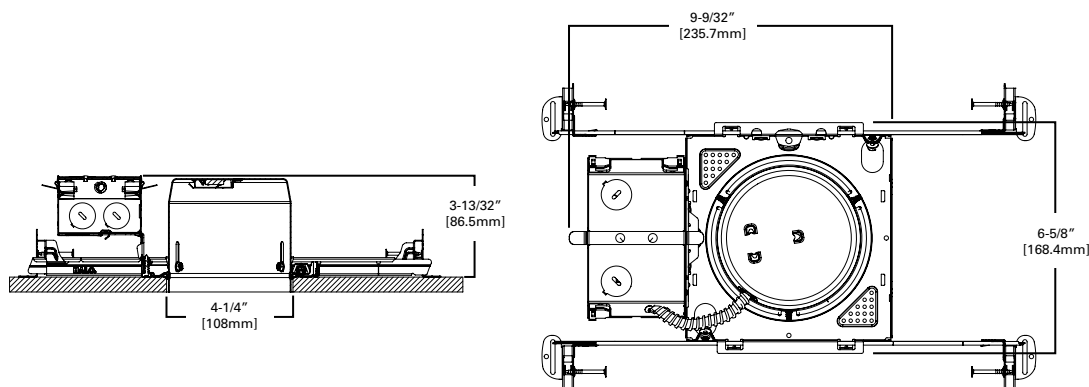



























ENERGY DATA		
Input Voltage	120V	277V
Input Current	0.099 (mA)	(mA)
Input Power	11.89 (W)	(W)
Inrush (A)	2 (A)	(A)
THD: ≤ 20%		
PF: ≥ 0.90		
T Ambient -40 - +40°C		
Sound Rating ≤ 20dba		

Special Features

- Got-Nail™ bar hangers
- Pass-N-Thru™ bar hangers
- Quick Connect™ push wire nuts
- Air-Tite™ code compliant
- Slide-N-Side™ junction box









ORDERING INFORMATION

A complete luminaire consists of a housing, lamp (by others) and trim. Ordered separately.

Housing	Trims	Accessories
E44MR16ICAT = 4" ultra-shallow recessed low voltage new construction housing, Gx5.3 base, 120/277V 60Hz	See below	L100 Series = Accessory 2" filters and lens, see specification sheet for details OT999P = Oversized trim ring accessory UMB4 = Universal mounting bracket, field installable
'Wafer Thin' Self Flanged MR16 Trim		
Use with new construction housing types only		10W Maximum / Gx5.3 Base
Directional Open		
 1430 Conical Reflector, Open, 35° Tilt 1430MWWF=Matte White, White Flange 1430H=Haze 1430HWF=Haze, White Flange 1430BN=Brushed Nickel 1430GB=German Bronze  1431 Conical Baffle, Open, 35° Tilt 1431WBWF=White Baffle, White Flange 1431BBWF=Black Baffle, White Flange 1431BN=Brushed Nickel 1431GB=German Bronze	 1434 Round Pinhole, Open, 35° Tilt 1434MW=Matte White 1434MB=Matte Black 1434BN=Brushed Nickel 1434GB=German Bronze  1435 Round Pinhole with Oculus, Open, 35° Tilt 1435MWWB=Matte White, White Baffle 1435MWBB=Matte White, Black Baffle 1435BNBB=Brushed Nickel, Black Baffle 1435GBBB=German Bronze, Black Baffle	 1464 Square Pinhole, Open, 35° Tilt 1464MW=Matte White 1464MB=Matte Black 1464BN=Brushed Nickel 1464GB=German Bronze  1465 Square Pinhole with Oculus, Open, 35° Tilt 1465MWWB=Matte White, White Baffle 1465MWBB=Matte White, Black Baffle 1465BNBB=Brushed Nickel, Black Baffle 1465GBBB=German Bronze, Black Baffle
Lens Wall Wash		
 1432 Angle Cut Conical Reflector, Lens Wall Wash 1432MWWF=Matte White, White Flange 1432H=Haze 1432HWF=Haze, White Flange	 1436 Round Pinhole, Lens Wall Wash 1436MWWB=Matte White, White Baffle 1436MWBB=Matte White, Black Baffle	 1466 Square Pinhole, Lens Wall Wash 1466MWWB=Matte White, White Baffle 1466MWBB=Matte White, Black Baffle
Directional Lens		
 1433 Conical Reflector, Diffuse Lens, 35° Tilt 1433MWWF=Matte White, White Flange 1433H=Haze 1433HWF=Haze, White Flange 1433BN=Brushed Nickel 1433GB=German Bronze	 1437 Round Pinhole, Diffuse Lens, 35° Tilt 1437MWWB=Matte White, White Baffle 1437MWBB=Matte White, Black Baffle 1437BNBB=Brushed Nickel, Black Baffle 1437GBBB=German Bronze, Black Baffle	 1467 Square Pinhole, Diffuse Lens, 35° Tilt 1467MWWB=Matte White, White Baffle 1467MWBB=Matte White, Black Baffle 1467BNBB=Brushed Nickel, Black Baffle 1467GBBB=German Bronze, Black Baffle
'Full Overlap' Self Flanged MR16 Trim		
Use with new construction and install from below remodeler type housing types		10W Maximum / Gx5.3 Base
Directional Open		
 1440 Conical Reflector, Open, 35° Tilt 1440MWWF=Matte White, White Flange 1440H=Haze 1440HWF=Haze, White Flange 1440BN=Brushed Nickel 1440GB=German Bronze  1441 Conical Baffle, Open, 35° Tilt 1441MBWF=White Baffle, White Flange 1441BBWF=Black Baffle, White Flange 1441BN=Brushed Nickel 1441GB=German Bronze	 1444 Round Pinhole, Open, 35° Tilt 1444MW=Matte White 1444MB=Matte Black 1444BN=Brushed Nickel 1444GB=German Bronze  1445 Round Pinhole with Oculus, Open, 35° Tilt 1445MWWB=Matte White, White Baffle 1445MWBB=Matte White, Black Baffle 1445BNBB=Brushed Nickel, Black Baffle 1445GBBB=German Bronze, Black Baffle	 1484 Square Pinhole, Open, 35° Tilt 1484MW=Matte White 1484MB=Matte Black 1484BN=Brushed Nickel 1484GB=German Bronze  1485 Square Pinhole with Oculus, Open, 35° Tilt 1485MWWB=Matte White, White Baffle 1485MWBB=Matte White, Black Baffle 1485BNBB=Brushed Nickel, Black Baffle 1485GBBB=German Bronze, Black Baffle
Lens Wall Wash		
 1442 Angle Cut Conical Reflector, Lens Wall Wash 1442MWWF=Matte White, White Flange 1442H=Haze 1442HWF=Haze, White Flange	 1446 Round Pinhole, Lens Wall Wash 1446MWWB=Matte White, White Baffle 1446MWBB=Matte White, Black Baffle	 1486 Square Pinhole, Lens Wall Wash 1486MWWB=Matte White, White Baffle 1486MWBB=Matte White, Black Baffle
Directional Lens		
 1443 Conical Reflector, Diffuse Lens, 35° Tilt 1443MWWF=Matte White, White Flange 1443H=Haze 1443HWF=Haze, White Flange 1443BN=Brushed Nickel 1443GB=German Bronze  1447 Round Pinhole, Diffuse Lens, 35° Tilt 1447MWWB=Matte White, White Baffle 1447MWBB=Matte White, Black Baffle 1447BNBB=Brushed Nickel, Black Baffle 1447GBBB=German Bronze, Black Baffle	 1449 Round 'All Acrylic-Glass' Diffuse Lens, 35° Tilt 1449AAG=All Acrylic Glass  1487 Square Pinhole, Diffuse Lens, 35° Tilt 1487MWWB=Matte White, White Baffle 1487MWBB=Matte White, Black Baffle 1487BNBB=Brushed Nickel, Black Baffle 1487GBBB=German Bronze, Black Baffle	 1489 Square 'All Acrylic-Glass' Diffuse Lens, 35° Tilt 1489AAG=All Acrylic Glass

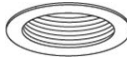
- Lens trims are wet location listed, covered ceilings only and IP44 rated
- Unless otherwise noted lamp rotates 360°, tilts 35° from nadir and adjusts from above and/or below the ceiling without tools holding any aiming angle

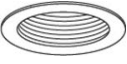
ORDERING INFORMATION (CONTINUED)

Die Cast Metal Trim Rings MR16 Trim		10W Maximum / Gx5.3 Base	
Use with new construction and install from below remodeler type housing types			
 1421 Precision Reflector, 35° Tilt 1421MB=Matte Black 1421W=White 1421H=Haze 1421C=Clear Specular 1421RG=Residential Gold 1421CG=Champagne Gold 1421SN=Satin Nickel 1421TBZ=Tuscan Bronze	 1420 Adjustable Slot Aperture, 35° Tilt 1420P=White 1420SN=Satin Nickel 1420TBZ=Tuscan Bronze	 1951 Regressed Clear Glass Showerlight, 15° Tilt 1951PS=White Trim, Clear Specular Splay 1951SNS=Satin Nickel, Clear Specular Splay 1951TBZS=Tuscan Bronze, Clear Specular Splay	
 1419 Pinhole Baffle 1419W=White Baffle, White Trim 1419P=Black Baffle, White Trim 1419SN=Black Baffle, Satin Nickel Trim 1419TBZ=Black Baffle, Tuscan Bronze Trim	 1493 Coilex® Baffle, 35° Tilt 1493W=White Baffle, Trim 1493P=Black Baffle, White Trim 1493BC=Black Baffle, Black Chrome Trim 1493SN=Black Baffle, Satin Nickel Trim 1493TBZ=Black Baffle, Tuscan Bronze Trim	 1496 Retractable Elbow, 60° Tilt 1496P=White 1496SN=Satin Nickel 1496TBZ=Tuscan Bronze	
 1453 Precision Metal Baffle, 35° Tilt 1453SN=Satin Nickel Baffle, Trim 1453TBZ=Tuscan Bronze Baffle, Trim	 1495 Adjustable Mirror Trim, 90° Tilt 1495P=White Gimbal, Trim 1495SN=Satin Nickel Gimbal, Trim 1495TBZ=Tuscan Bronze Gimbal, Trim	 1498 Adjustable Eyeball with Baffle, 30° Tilt 1498W=White Trim, Baffle 1498P=White Trim, Black Baffle 1498BC=Black Chrome Trim, Black Baffle 1498SN=Satin Nickel Trim, Black Baffle 1498TBZ=Tuscan Bronze Trim, Black Baffle	

PHOTOMETRICS - DIRECTIONALS

Notes and Definitions:

Luminance: To convert cd/m² to footlamberts, multiply by 0.2919

• Beam spread is to 50% center beam candlepower (CBCP)

• Data shown is based on bare lamp photometrics.

D=Distance to floor or wall.

FC=Footcandles on floor or wall at center beam aiming location.

L=Effective Visual Beam length in feet (50% of maximum footcandle level.)

W=Effective Visual Beam width in feet (50% of maximum footcandle level.)

CB=Distance across or down to center beam location.

The "real world photometrics" shown here are from off the shelf lamps in fixtures using a clear lens and operated at 12.0 volts. Please see page 64 & 65 of the IRiS catalog for a further discussion and appropriate correction multipliers.

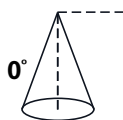
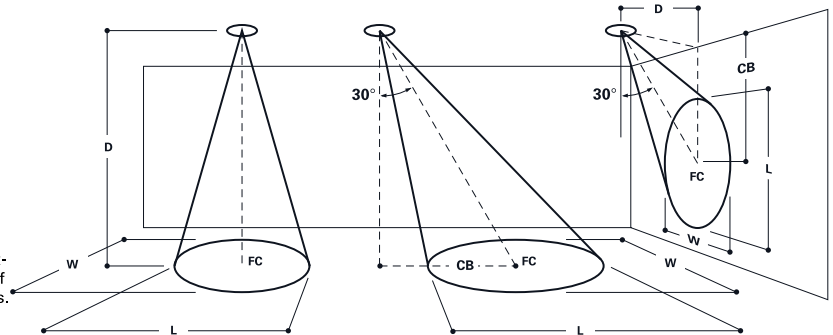

Trims	Lamp	0° Aiming Angle Horizontal Footcandles				30° Aiming Angle Horizontal Footcandles					30° Aiming Angle Vertical Footcandles				
		MH	FC	L	W	MH	FC	L	W	CB	MH	FC	L	W	CB
1430MWWF 1440MWWF	7MR16 EXPERTCOLOR S10 930 D 10/1 Lumens: 481lm Beam Angle: 9.8° CBCP: 6258cd	6'	167.7	1	1	6'	95.9	1.4	1	3.5	2'	209.6	1.2	0.6	3.5
		8'	94.3	1.2	1.2	8'	54	1.9	1.4	4.6	3'	93.2	1.8	0.8	5.2
		10'	60.4	1.6	1.6	10'	34.5	2.3	1.8	5.8	4'	52.4	2.5	1.2	6.9
		12.5'	38.6	2	2	12.5'	22.1	2.9	2.4	7.2	5'	33.5	3.1	1.4	8.7
		Test #: G1-1804-707-1		Test #: G1-1804-707-12					Test #: G1-1804-707-12						
7MR16 EXPERTCOLOR F25 930 D 10/1	Lumens: 497lm Beam Angle: 20.8° CBCP: 2526cd	6'	67.1	2	2	6'	45.4	2.7	2.2	3.5	2'	98.9	2	1.2	3.5
		8'	37.7	2.8	2.8	8'	25.5	3.5	3	4.6	3'	44	3	1.8	5.2
		10'	24.1	3.4	3.4	10'	16.3	4.5	3.8	5.8	4'	24.7	4	2.4	6.9
		12.5'	15.4	4.4	4.4	12.5'	10.5	5.6	4.8	7.2	5'	15.8	5.1	3	8.7
		Test #: G1-1804-707-23		Test #: G1-1804-707-37					Test #: G1-1804-707-37						
7MR16 EXPERTCOLOR F35 930 D 10/1	Lumens: 487lm Beam Angle: 30.6° CBCP: 1457cd	6'	39.2	3	3	6'	27.7	3.6	3.4	3.5	2'	67.3	2.1	1.6	3.5
		8'	22	4	4	8'	15.6	4.8	4.4	4.6	3'	29.9	3.2	2.4	5.2
		10'	14.1	5	5	10'	10	6.1	5.6	5.8	4'	16.8	4.3	3.2	6.9
		12.5'	9	6.2	6.2	12.5'	6.4	7.6	7	7.2	5'	10.8	5.5	4	8.7
		Test #: G1-1804-707-48		Test #: G1-1804-707-59					Test #: G1-1804-707-59						

PHOTOMETRICS - DIRECTIONALS (CONTINUED)

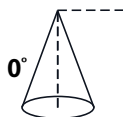

Trims	Lamp	0° Aiming Angle Horizontal Footcandles				30° Aiming Angle Horizontal Footcandles					30° Aiming Angle Vertical Footcandles				
		MH	FC	L	W	MH	FC	L	W	CB	MH	FC	L	W	CB
1431WBWF 1441WBWF	7MR16 EXPERTCOLOR S10 930 D 10/1 Lumens: 481lm Beam Angle: 9.8° CBCP: 6258cd	6'	167.3	1	1	6'	101.2	1.3	1	3.5	2'	192.4	1.3	0.6	3.5
		8'	94.1	1.2	1.2	8'	57	1.8	1.4	4.6	3'	85.5	2	0.8	5.2
		10'	60.2	1.6	1.6	10'	36.4	2.2	1.8	5.8	4'	48.1	2.7	1.2	6.9
		12.5'	38.5	2	2	12.5'	23.3	2.9	2.4	7.2	5'	30.8	3.3	1.6	8.7
		Test #: G1-1804-707-2				Test #: G1-1804-707-13					Test #: G1-1804-707-13				
7MR16 EXPERTCOLOR F25 930 D 10/1	Lumens: 497lm Beam Angle: 20.8° CBCP: 2526cd	6'	68.4	2	2	6'	45.5	2.6	2.2	3.5	2'	100.5	2	1.2	3.5
		8'	38.5	2.8	2.8	8'	25.6	3.5	3	4.6	3'	44.7	3	1.8	5.2
		10'	24.6	3.4	3.4	10'	16.4	4.4	3.8	5.8	4'	25.1	4	2.4	6.9
		12.5'	15.8	4.4	4.4	12.5'	10.5	5.5	4.8	7.2	5'	16.1	5	3	8.7
		Test #: G1-1804-707-24				Test #: G1-1804-707-38					Test #: G1-1804-707-38				
7MR16 EXPERTCOLOR F35 930 D 10/1	Lumens: 487lm Beam Angle: 30.6° CBCP: 1457cd	6'	39.1	3	3	6'	27.1	3.6	3.4	3.5	2'	69.3	2	1.4	3.5
		8'	22	4	4	8'	15.2	4.9	4.4	4.6	3'	30.8	3.1	2.4	5.2
		10'	14.1	5	5	10'	9.8	6.1	5.6	5.8	4'	17.3	4.1	3.2	6.9
		12.5'	9	6.2	6.2	12.5'	6.2	7.7	7	7.2	5'	11.1	5.2	4	8.7
		Test #: G1-1804-707-49				Test #: G1-1804-707-60					Test #: G1-1804-707-60				
1434MW 1444MW	7MR16 EXPERTCOLOR S10 930 D 10/1 Lumens: 481lm Beam Angle: 9.8° CBCP: 6258cd	6'	162.4	1	1	6'	97.4	1.3	1	3.5	2'	192.2	1.2	0.6	3.5
		8'	91.4	1.4	1.4	8'	54.8	1.8	1.4	4.6	3'	85.4	1.9	0.8	5.2
		10'	58.5	1.6	1.6	10'	35.1	2.2	1.8	5.8	4'	48.1	2.6	1.2	6.9
		12.5'	37.4	2	2	12.5'	22.4	2.8	2.2	7.2	5'	30.8	3.3	1.4	8.7
		Test #: G1-1804-707-4				Test #: G1-1804-707-15					Test #: G1-1804-707-15				
7MR16 EXPERTCOLOR F25 930 D 10/1	Lumens: 497lm Beam Angle: 20.8° CBCP: 2526cd	6'	66.6	2	2	6'	45.8	2.5	2.2	3.5	2'	90.9	2	1.2	3.5
		8'	37.4	2.8	2.8	8'	25.8	3.4	3	4.6	3'	40.4	3.1	1.8	5.2
		10'	24	3.4	3.4	10'	16.5	4.2	3.8	5.8	4'	22.7	4.1	2.4	6.9
		12.5'	15.3	4.2	4.2	12.5'	10.6	5.3	4.8	7.2	5'	14.5	5.3	3	8.7
		Test #: G1-1804-707-27				Test #: G1-1804-707-40					Test #: G1-1804-707-40				
7MR16 EXPERTCOLOR F35 930 D 10/1	Lumens: 487lm Beam Angle: 30.6° CBCP: 1457cd	6'	38.4	3	3	6'	27.2	3.5	3.4	3.5	2'	65	2	1.6	3.5
		8'	21.6	4	4	8'	15.3	4.7	4.4	4.6	3'	28.9	3	2.4	5.2
		10'	13.8	5	5	10'	9.8	5.9	5.6	5.8	4'	16.3	4.1	3.2	6.9
		12.5'	8.8	6.2	6.2	12.5'	6.3	7.3	7	7.2	5'	10.4	5	4	8.7
		Test #: G1-1804-707-51				Test #: G1-1804-707-62					Test #: G1-1804-707-62				

PHOTOMETRICS - DIRECTIONALS (CONTINUED)

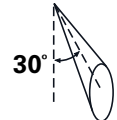
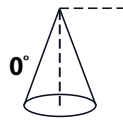

Trims	Lamp	0° Aiming Angle Horizontal Footcandles				30° Aiming Angle Horizontal Footcandles					30° Aiming Angle Vertical Footcandles				
		MH	FC	L	W	MH	FC	L	W	CB	MH	FC	L	W	CB
1435MWWB 1445MWWB	7MR16 EXPERTCOLOR S10 930 D 10/1 Lumens: 481lm Beam Angle: 9.8° CBCP: 6258cd	6'	168.5	1	1	6'	97.6	1.3	1	3.5	2'	169.6	1.4	0.6	3.5
		8'	94.8	1.2	1.2	8'	54.9	1.8	1.4	4.6	3'	75.4	2.1	0.8	5.2
		10'	60.7	1.6	1.6	10'	35.2	2.3	1.8	5.8	4'	42.4	2.8	1.2	6.9
		12.5'	38.8	2	2	12.5'	22.5	2.8	2.2	7.2	5'	27.1	3.6	1.6	8.7
		Test #: G1-1804-707-5					Test #: G1-1804-707-16					Test #: G1-1804-707-16			
	7MR16 EXPERTCOLOR F25 930 D 10/1 Lumens: 497lm Beam Angle: 20.8° CBCP: 2526cd	6'	67.1	2	2	6'	45.4	2.5	2.2	3.5	2'	94.1	1.9	1.2	3.5
		8'	37.7	2.6	2.6	8'	25.5	3.3	3	4.6	3'	41.8	3	1.8	5.2
		10'	24.2	3.4	3.4	10'	16.3	4.3	3.8	5.8	4'	23.5	4	2.4	6.9
		12.5'	15.5	4.2	4.2	12.5'	10.5	5.3	4.8	7.2	5'	15.1	5	3	8.7
		Test #: G1-1804-707-28					Test #: G1-1804-707-41					Test #: G1-1804-707-41			
	7MR16 EXPERTCOLOR F35 930 D 10/1 Lumens: 487lm Beam Angle: 30.6° CBCP: 1457cd	6'	39.2	3	3	6'	27.3	3.5	3.4	3.5	2'	66.3	1.9	1.6	3.5
		8'	22.1	4	4	8'	15.3	4.8	4.6	4.6	3'	29.5	3	2.4	5.2
		10'	14.1	5	5	10'	9.8	6	5.6	5.8	4'	16.6	4	3.2	6.9
		12.5'	9	6.2	6.2	12.5'	6.3	7.5	7.2	7.2	5'	10.6	5.1	4	8.7
		Test #: G1-1804-707-52					Test #: G1-1804-707-63					Test #: G1-1804-707-63			
1464MW 1484MW	7MR16 EXPERTCOLOR S10 930 D 10/1 Lumens: 481lm Beam Angle: 9.8° CBCP: 6258cd	6'	166.4	1	1	6'	95	1.4	1	3.5	2'	197.9	1.2	0.6	3.5
		8'	93.6	1.4	1.4	8'	53.4	1.8	1.4	4.6	3'	87.9	1.8	0.8	5.2
		10'	59.9	1.6	1.6	10'	34.2	2.3	1.8	5.8	4'	49.5	2.5	1.2	6.9
		12.5'	38.3	2.2	2.2	12.5'	21.9	2.9	2.4	7.2	5'	31.7	3.2	1.4	8.7
		Test #: G1-1804-707-8					Test #: G1-1804-707-19					Test #: G1-1804-707-19			
	7MR16 EXPERTCOLOR F25 930 D 10/1 Lumens: 497lm Beam Angle: 20.8° CBCP: 2526cd	6'	66.7	2	2	6'	44.7	2.5	2.2	3.5	2'	98.6	1.9	1.2	3.5
		8'	37.5	2.8	2.6	8'	25.1	3.4	3	4.6	3'	43.8	2.9	1.8	5.2
		10'	24	3.4	3.4	10'	16.1	4.2	3.8	5.8	4'	24.6	4	2.4	6.9
		12.5'	15.4	4.4	4.2	12.5'	10.3	5.4	4.8	7.2	5'	15.8	5	3	8.7
		Test #: G1-1804-707-32					Test #: G1-1804-707-44					Test #: G1-1804-707-44			
	7MR16 EXPERTCOLOR F35 930 D 10/1 Lumens: 487lm Beam Angle: 30.6° CBCP: 1457cd	6'	39.7	2.8	3	6'	27.5	3.5	3.4	3.5	2'	65.3	2.1	1.6	3.5
		8'	22.3	3.8	4	8'	15.4	4.7	4.6	4.6	3'	29	3.1	2.4	5.2
		10'	14.3	4.8	5	10'	9.9	5.9	5.6	5.8	4'	16.3	4.2	3.2	6.9
		12.5'	9.1	6.2	6.2	12.5'	6.3	7.5	7	7.2	5'	10.4	5.2	4	8.7
		Test #: G1-1804-707-55					Test #: G1-1804-707-71					Test #: G1-1804-707-71			

PHOTOMETRICS - DIRECTIONALS (CONTINUED)

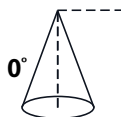

Trims	Lamp	0° Aiming Angle Horizontal Footcandles				30° Aiming Angle Horizontal Footcandles					30° Aiming Angle Vertical Footcandles				
		MH	FC	L	W	MH	FC	L	W	CB	MH	FC	L	W	CB
1465MWWB 1485MWWB	7MR16 EXPERTCOLOR S10 930 D 10/1 Lumens: 481lm Beam Angle: 9.8° CBCP: 6258cd	6'	166.3	1	1	6'	87.9	1.3	1	3.5	2'	191.5	1.2	0.6	3.5
		8'	93.5	1.4	1.4	8'	49.5	1.9	1.4	4.6	3'	85.1	1.9	0.8	5.2
		10'	59.9	1.6	1.6	10'	31.7	2.4	1.8	5.8	4'	47.9	2.6	1.2	6.9
		12.5'	38.3	2.2	2.2	12.5'	20.3	3	2.4	7.2	5'	30.6	3.1	1.4	8.7
		Test #: G1-1804-707-9				Test #: G1-1804-707-20					Test #: G1-1804-707-20				
	7MR16 EXPERTCOLOR F25 930 D 10/1 Lumens: 497lm Beam Angle: 20.8° CBCP: 2526cd	6'	66.8	2	2	6'	45.6	2.5	2.2	3.5	2'	92.7	2	1.2	3.5
		8'	37.6	2.6	2.8	8'	25.6	3.3	3	4.6	3'	41.2	2.9	1.8	5.2
		10'	24	3.4	3.4	10'	16.4	4.2	3.8	5.8	4'	23.2	4	2.4	6.9
		12.5'	15.4	4.2	4.2	12.5'	10.5	5.3	4.8	7.2	5'	14.8	5	3	8.7
		Test #: G1-1804-707-33				Test #: G1-1804-707-4					Test #: G1-1804-707-45				
	7MR16 EXPERTCOLOR F35 930 D 10/1 Lumens: 487lm Beam Angle: 30.6° CBCP: 1457cd	6'	38.9	3	3	6'	27.4	3.4	3.4	3.5	2'	61.5	1.9	1.6	3.5
		8'	21.9	4	4	8'	15.4	4.6	4.6	4.6	3'	27.3	3	2.6	5.2
		10'	14	5	5	10'	9.9	5.7	5.6	5.8	4'	15.4	4	3.4	6.9
		12.5'	9	6.2	6.4	12.5'	6.3	7.2	7.2	7.2	5'	9.8	5.1	4.2	8.7
		Test #: G1-1804-707-56				Test #: G1-1804-707-72					Test #: G1-1804-707-72				
1433MWWF 1443MWWF	7MR16 EXPERTCOLOR S10 930 D 10/1 Lumens: 481lm Beam Angle: 9.8° CBCP: 6258cd	6'	25.1	2.8	2.8	6'	12.4	3.7	3.2	3.5	2'	30.1	2.5	1.6	3.5
		8'	14.1	3.6	3.6	8'	7	5	4.4	4.6	3'	13.4	3.9	2.4	5.2
		10'	9	4.6	4.6	10'	4.5	6.4	5.4	5.8	4'	7.5	5.2	3.2	6.9
		12.5'	5.8	5.8	5.8	12.5'	2.9	7.9	6.8	7.2	5'	4.8	6.6	4	8.7
		G1-1804-707-3				Test #: G1-1804-707-14					Test #: G1-1804-707-14				
	7MR16 EXPERTCOLOR F25 930 D 10/1 Lumens: 497lm Beam Angle: 20.8° CBCP: 2526cd	6'	19.8	3.2	3.2	6'	10.5	4	3.8	3.5	2'	27.5	2.4	1.8	3.5
		8'	11.1	4.2	4.2	8'	5.9	5.4	5	4.6	3'	12.2	3.7	2.6	5.2
		10'	7.1	5.4	5.4	10'	3.8	6.7	6.2	5.8	4'	6.9	5	3.6	6.9
		12.5'	4.6	6.8	6.8	12.5'	2.4	8.5	7.6	7.2	5'	4.4	6.2	4.4	8.7
		Test #: G1-1804-707-26				Test #: G1-1804-707-39					Test #: G1-1804-707-39				
	7MR16 EXPERTCOLOR F35 930 D 10/1 Lumens: 487lm Beam Angle: 30.6° CBCP: 1457cd	6'	15.8	3.6	3.6	6'	8.6	4.4	4.2	3.5	2'	25.1	2.3	1.8	3.5
		8'	8.9	5	5	8'	4.9	5.8	5.6	4.6	3'	11.2	3.6	2.8	5.2
		10'	5.7	6.2	6.2	10'	3.1	7.3	7	5.8	4'	6.3	4.8	3.8	6.9
		12.5'	3.6	7.8	7.8	12.5'	2	9.3	8.8	7.2	5'	4	6.1	4.8	8.7
		Test #: G1-1804-707-50				Test #: G1-1804-707-61					Test #: G1-1804-707-61				

PHOTOMETRICS - DIRECTIONALS (CONTINUED)

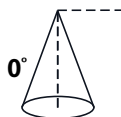

Trims	Lamp	0° Aiming Angle Horizontal Footcandles				30° Aiming Angle Horizontal Footcandles					30° Aiming Angle Vertical Footcandles				
		MH	FC	L	W	MH	FC	L	W	CB	MH	FC	L	W	CB
1437MWWB 1447MWWB	7MR16 EXPERTCOLOR S10 930 D 10/1 Lumens: 481lm Beam Angle: 9.8° CBCP: 6258cd	6'	95.2	1.4	1.4	6'	54.5	1.9	1.6	3.5	2'	105.8	1.9	0.8	3.5
		8'	53.5	1.8	1.8	8'	30.7	2.6	2	4.6	3'	47	2.9	1.4	5.2
		10'	34.3	2.4	2.4	10'	19.6	3.2	2.6	5.8	4'	26.5	3.9	1.8	6.9
		12.5'	21.9	3	3	12.5'	12.6	4	3.4	7.2	5'	16.9	4.8	2.2	8.7
		Test #: G1-1804-707-6				Test #: G1-1804-707-17					Test #: G1-1804-707-17				
	7MR16 EXPERTCOLOR F25 930 D 10/1 Lumens: 497lm Beam Angle: 20.8° CBCP: 2526cd	6'	51.4	2.2	2.2	6'	32.2	2.8	2.6	3.5	2'	70.7	2.1	1.2	3.5
		8'	28.9	3	3	8'	18.1	3.7	3.4	4.6	3'	31.4	3.2	2	5.2
		10'	18.5	3.8	3.8	10'	11.6	4.7	4.4	5.8	4'	17.7	4.3	2.6	6.9
		12.5'	11.8	4.6	4.6	12.5'	7.4	5.8	5.6	7.2	5'	11.3	5.4	3.4	8.7
		Test #: G1-1804-707-30				Test #: G1-1804-707-42					Test #: G1-1804-707-42				
	7MR16 EXPERTCOLOR F35 930 D 10/1 Lumens: 487lm Beam Angle: 30.6° CBCP: 1457cd	6'	32.6	3	3	6'	22.1	3.6	3.4	3.5	2'	54.4	2	1.6	3.5
		8'	18.3	4	4	8'	12.4	4.7	4.6	4.6	3'	24.2	3.1	2.4	5.2
		10'	11.7	5	5	10'	8	5.9	5.8	5.8	4'	13.6	4.2	3.2	6.9
		12.5'	7.5	6.4	6.4	12.5'	5.1	7.5	7.2	7.2	5'	8.7	5.3	4.2	8.7
		Test #: G1-1804-707-53				Test #: G1-1804-707-64					Test #: G1-1804-707-64				
1467MWWB 1487MWWB	7MR16 EXPERTCOLOR S10 930 D 10/1 Lumens: 481lm Beam Angle: 9.8° CBCP: 6258cd	6'	95.6	1.4	1.4	6'	54.4	1.8	1.8	3.5	2'	94.1	1.8	1	3.5
		8'	53.8	1.8	2	8'	30.6	2.4	2.4	4.6	3'	41.8	2.8	1.6	5.2
		10'	34.4	2.2	2.6	10'	19.6	3	3	5.8	4'	23.5	3.8	2	6.9
		12.5'	22	2.8	3.2	12.5'	12.5	3.9	3.8	7.2	5'	15.1	4.7	2.6	8.7
		Test #: G1-1804-707-10				Test #: G1-1804-707-21					Test #: G1-1804-707-21				
	7MR16 EXPERTCOLOR F25 930 D 10/1 Lumens: 497lm Beam Angle: 20.8° CBCP: 2526cd	6'	53.9	2.2	2.2	6'	32.2	2.6	2.6	3.5	2'	76.3	1.9	1.4	3.5
		8'	30.3	2.8	3	8'	18.1	3.6	3.6	4.6	3'	33.9	2.9	2	5.2
		10'	19.4	3.6	3.8	10'	11.6	4.5	4.4	5.8	4'	19.1	3.9	2.8	6.9
		12.5'	12.4	4.6	4.8	12.5'	7.4	5.7	5.6	7.2	5'	12.2	4.8	3.4	8.7
		Test #: G1-1804-707-35				Test #: G1-1804-707-46					Test #: G1-1804-707-46				
	7MR16 EXPERTCOLOR F35 930 D 10/1 Lumens: 487lm Beam Angle: 30.6° CBCP: 1457cd	6'	32.6	3	3	6'	21.1	3.5	3.4	3.5	2'	51.9	2	1.6	3.5
		8'	18.3	4	4	8'	11.9	4.6	4.6	4.6	3'	23.1	3.2	2.4	5.2
		10'	11.7	5	5	10'	7.6	5.7	5.8	5.8	4'	13	4.2	3.4	6.9
		12.5'	7.5	6.4	6.2	12.5'	4.9	7.3	7.2	7.2	5'	8.3	5.3	4.2	8.7
		Test #: G1-1804-707-57				Test #: G1-1804-707-73					Test #: G1-1804-707-73				

PHOTOMETRICS - DIRECTIONALS (CONTINUED)

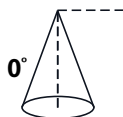

Trims	Lamp	0° Aiming Angle Horizontal Footcandles				30° Aiming Angle Horizontal Footcandles					30° Aiming Angle Vertical Footcandles				
		MH	FC	L	W	MH	FC	L	W	CB	MH	FC	L	W	CB
1449 AAG	7MR16 EXPERTCOLOR S10 930 D 10/1 Lumens: 481lm Beam Angle: 9.8° CBCP: 6258cd	6'	58.3	1.6	1.6	6'	34.6	2.2	1.8	3.5	2'	61.9	2.1	1	3.5
		8'	32.8	2.2	2.2	8'	19.5	3.1	2.6	4.6	3'	27.5	3.2	1.6	5.2
		10'	21	2.6	2.6	10'	12.5	3.9	3.2	5.8	4'	15.5	4.3	2.2	6.9
		12.5'	13.4	3.4	3.4	12.5'	8	4.9	4	7.2	5'	9.9	5.4	2.8	8.7
		Test #: G1-1804-707-7				Test #: G1-1804-707-18					Test #: G1-1804-707-18				
	7MR16 EXPERTCOLOR F25 930 D 10/1 Lumens: 497lm Beam Angle: 20.8° CBCP: 2526cd	6'	36.6	2.4	2.4	6'	22.2	3.2	3	3.5	2'	54.2	2.1	1.4	3.5
		8'	20.6	3.2	3.2	8'	12.5	4.3	4	4.6	3'	24.1	3.3	2	5.2
		10'	13.2	4	4	10'	8	5.5	5	5.8	4'	13.5	4.4	2.8	6.9
		12.5'	8.4	5.2	5.2	12.5'	5.1	6.8	6.2	7.2	5'	8.7	5.6	3.4	8.7
		Test #: G1-1804-707-31				Test #: G1-1804-707-43					Test #: G1-1804-707-43				
	7MR16 EXPERTCOLOR F35 930 D 10/1 Lumens: 487lm Beam Angle: 30.6° CBCP: 1457cd	6'	25.7	3	3	6'	17	3.8	3.6	3.5	2'	42.2	2.3	1.6	3.5
		8'	14.4	4.2	4.2	8'	9.6	5.1	4.8	4.6	3'	18.7	3.5	2.4	5.2
		10'	9.2	5.2	5.2	10'	6.1	6.3	6	5.8	4'	10.5	4.6	3.4	6.9
		12.5'	5.9	6.6	6.6	12.5'	3.9	8	7.4	7.2	5'	6.7	5.9	4.2	8.7
		Test #: G1-1804-707-54				Test #: G1-1804-707-65					Test #: G1-1804-707-65				
1489 AAG	7MR16 EXPERTCOLOR S10 930 D 10/1 Lumens: 481lm Beam Angle: 9.8° CBCP: 6258cd	6'	48.1	1.8	1.8	6'	24.7	2.8	2.2	3.5	2'	50.1	2.1	1.2	3.5
		8'	27.1	2.4	2.4	8'	13.9	3.7	3	4.6	3'	22.2	3.3	1.8	5.2
		10'	17.3	3.2	3	10'	8.9	4.7	3.8	5.8	4'	12.5	4.3	2.4	6.9
		12.5'	11.1	4	3.8	12.5'	5.7	5.9	4.8	7.2	5'	8	5.5	3	8.7
		Test #: G1-1804-707-11				Test #: G1-1804-707-22					Test #: G1-1804-707-22				
	7MR16 EXPERTCOLOR F25 930 D 10/1 Lumens: 497lm Beam Angle: 20.8° CBCP: 2526cd	6'	33.9	2.6	2.4	6'	19.1	3.3	3	3.5	2'	45.4	2.2	1.4	3.5
		8'	19	3.4	3.4	8'	10.8	4.4	4	4.6	3'	20.2	3.3	2.2	5.2
		10'	12.2	4.2	4.2	10'	6.9	5.5	5	5.8	4'	11.3	4.5	2.8	6.9
		12.5'	7.8	5.4	5.2	12.5'	4.4	6.9	6.4	7.2	5'	7.3	5.6	3.6	8.7
		Test #: G1-1804-707-36				Test #: G1-1804-707-47					Test #: G1-1804-707-47				
	7MR16 EXPERTCOLOR F35 930 D 10/1 Lumens: 487lm Beam Angle: 30.6° CBCP: 1457cd	6'	24.3	3.2	3.2	6'	14.8	3.6	3.6	3.5	2'	35.1	2.3	1.6	3.5
		8'	13.7	4.2	4.2	8'	8.4	4.8	4.8	4.6	3'	15.6	3.4	2.6	5.2
		10'	8.8	5.2	5.2	10'	5.3	6	6	5.8	4'	8.8	4.7	3.4	6.9
		12.5'	5.6	6.6	6.6	12.5'	3.4	7.5	7.4	7.2	5'	5.6	5.9	4.4	8.7
		Test #: G1-1804-707-58				Test #: G1-1804-707-69					Test #: G1-1804-707-69				

PHOTOMETRICS - WALL WASH

Notes and Formulas

- Illuminance values for multiple fixtures are based upon the center two units of a four unit array. Footcandle values are centerline of fixtures and centered between fixtures.
- Illuminance values are cosine corrected initial values with no contribution from inter reflections from other room surfaces. Total illumination may increase from contributions from other surfaces.
- DD=Distance Down from Ceiling.
- Changing fixture spacing will affect illuminance level.

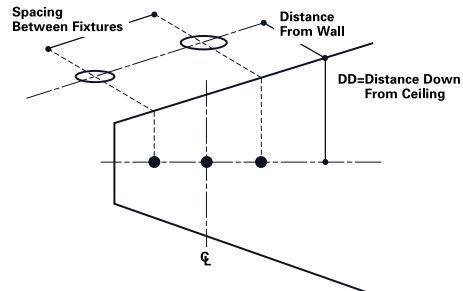

$$\text{New Fc} = \frac{\text{Existing Spacing}}{\text{New Spacing}} \times \text{Average Table Fc Level}$$

For optimal wall washing, space fixtures equal to the distance from the wall.

Single Footcandles
3' from wall (distance from fixture along wall)

Trims	Lamp	DD	•	1'	2'	3'	4'	5'	6'
1432MWWF	7MR16 EXPERTCOLOR F25 930 D 10/1	1'	1.3	0.9	0.4	0.1	0.1	0	0
1442MWWF	Lumens: 497lm Beam Angle: 20.8° CBCP: 2526cd	2'	3.3	2.7	1.5	0.7	0.3	0.1	0.1
		3'	3.4	2.8	1.7	1	0.5	0.3	0.2
		4'	3	2.6	1.7	1	0.6	0.3	0.2
		5'	2.5	2.2	1.5	0.9	0.5	0.3	0.2
		6'	1.9	1.7	1.3	0.8	0.5	0.3	0.2
		7'	1.5	1.3	1	0.7	0.5	0.3	0.2
		8'	1.1	1	0.8	0.6	0.4	0.3	0.2
		9'	0.8	0.8	0.7	0.5	0.4	0.3	0.2
		10'	0.6	0.6	0.5	0.4	0.3	0.2	0.2

Test #: G1-1804-707-25

Multiple Unit Footcandles
2' from wall (spacing between fixtures)

•	- 2'-	•	•	- 3'-	•
3.4	3.6	3.4	3	2.2	3
6.8	7.4	6.8	5.7	5.5	5.7
6.6	7.2	6.6	5.6	5.5	5.6
5.6	6.1	5.6	4.8	4.8	4.8
4.3	4.8	4.3	3.7	3.9	3.7
3.3	3.5	3.3	2.8	3	2.8
2.4	2.6	2.4	2.1	2.3	2.1
1.8	1.9	1.8	1.6	1.7	1.6
1.3	1.4	1.3	1.2	1.3	1.2
1	1.1	1	0.9	1	0.9

Test #: G1-1804-707-25

3' from wall (spacing between fixtures)

•	- 2'-	•	•	- 3'-	•
1.6	1.8	1.6	1.4	1.3	1.4
4.8	5.4	4.8	4.1	4.2	4.1
5.1	5.6	5.1	4.4	4.5	4.4
4.7	5.1	4.7	4	4.2	4
4	4.3	4	3.4	3.7	3.4
3.2	3.5	3.2	2.8	3	2.8
2.5	2.7	2.5	2.2	2.4	2.2
1.9	2.1	1.9	1.7	1.9	1.7
1.5	1.6	1.5	1.3	1.5	1.3
1.2	1.2	1.2	1.1	1.1	1.1

Test #: G1-1804-707-25

PHOTOMETRICS - WALL WASH (CONTINUED)

Trims	Lamp	Single Footcandles 3' from wall (distance from fixture along wall)								
		DD	•	1'	2'	3'	4'	5'	6'	
1436MWWB	7MR16 EXPERTCOLOR F25 930 D 10/1 Lumens: 497lm Beam Angle: 20.8° CBCP: 2526cd	1	0.7	0.3	0.1	0.1	0	0	0	
1446MWWB		3.8	2.7	1.3	0.5	0.2	0.1	0	0.1	
		5.9	4.3	2	0.9	0.4	0.2	0.1	0.2	
		6.7	5.1	2.5	1.1	0.5	0.2	0.1	0.2	
		6.1	4.8	2.7	1.2	0.6	0.3	0.2	0.2	
		4.9	4.1	2.5	1.3	0.6	0.3	0.2	0.2	
		3.7	3.2	2.1	1.2	0.6	0.3	0.2	0.2	
		2.8	2.4	1.7	1.1	0.6	0.3	0.2	0.2	
		2	1.8	1.4	0.9	0.6	0.3	0.2	0.2	
		1.5	1.4	1.1	0.8	0.5	0.3	0.2	0.2	
Test #: G1-1804-707-29										

Multiple Unit Footcandles 2' from wall (spacing between fixtures)						3' from wall (spacing between fixtures)					
•	- 2'-	•	•	- 3'-	•	•	- 2'-	•	•	- 3'-	•
2.7	2.9	2.7	2.4	1.7	2.4	1.3	1.5	1.3	1.1	1.1	1.1
8.4	8.7	8.4	7.4	5.5	7.4	5	5.4	5	4.3	3.8	4.3
11.9	12.4	11.9	10.3	8.1	10.3	7.9	8.6	7.9	6.7	6.1	6.7
11.9	12.9	11.9	10.2	8.8	10.2	9.2	10.1	9.2	7.8	7.4	7.8
9.8	10.8	9.8	8.3	7.9	8.3	8.7	9.7	8.7	7.3	7.4	7.3
7.4	8.2	7.4	6.2	6.4	6.2	7.4	8.1	7.4	6.2	6.5	6.2
5.4	5.9	5.4	4.6	4.9	4.6	5.8	6.4	5.8	4.9	5.3	4.9
4	4.3	4	3.4	3.7	3.4	4.5	4.9	4.5	3.8	4.2	3.8
2.9	3.1	2.9	2.5	2.7	2.5	3.4	3.7	3.4	2.9	3.2	2.9
2.2	2.3	2.2	0.9	1	0.9	2.6	2.8	2.6	2.3	2.5	2.3
Test #: G1-1804-707-29						Test #: G1-1804-707-29					

Trims	Lamp	Single Footcandles 3' from wall (distance from fixture along wall)								
		DD	•	1'	2'	3'	4'	5'	6'	
1466MWWB	7MR16 EXPERTCOLOR F25 930 D 10/1 Lumens: 497lm Beam Angle: 20.8° CBCP: 2526cd	0.8	0.7	0.3	0.1	0.1	0	0	0	
1486MWWB		3.7	2.6	1.2	0.5	0.2	0.1	0	0.1	
		6.4	4.5	2	0.8	0.3	0.2	0.1	0.2	
		7.7	5.5	2.6	1	0.4	0.2	0.1	0.2	
		7	5.3	2.7	1.2	0.5	0.3	0.1	0.2	
		5.7	4.5	2.5	1.2	0.6	0.3	0.2	0.2	
		4.3	3.6	2.2	1.2	0.6	0.3	0.2	0.2	
		3.2	2.7	1.8	1	0.6	0.3	0.2	0.2	
		2.3	2.1	1.5	0.9	0.5	0.3	0.2	0.2	
		1.7	1.6	1.2	0.8	0.5	0.3	0.2	0.2	
Test #: G1-1804-707-34										

Multiple Unit Footcandles 2' from wall (spacing between fixtures)						3' from wall (spacing between fixtures)					
•	- 2'-	•	•	- 3'-	•	•	- 2'-	•	•	- 3'-	•
2.2	2.5	2.2	1.9	1.7	1.9	1.1	1.3	1.1	0.9	1	0.9
8.6	8.6	8.6	7.6	5.3	7.6	4.9	5.3	4.9	4.2	3.7	4.2
13.1	13.3	13.1	11.5	8.2	11.5	8.4	9.1	8.4	7.2	6.2	7.2
13.3	13.9	13.3	11.5	9.1	11.5	10.2	11	10.2	8.7	7.7	8.7
11	11.9	11	9.3	8.4	9.3	9.7	10.6	9.7	8.2	7.9	8.2
8.3	9.1	8.3	7	6.8	7	8.2	9.1	8.2	6.9	7	6.9
6	6.6	6	5.1	5.3	5.1	6.5	7.1	6.5	5.5	5.8	5.5
4.4	4.8	4.4	3.7	4	3.7	5	5.5	5	4.2	4.6	4.2
3.2	3.5	3.2	2.7	3	2.7	3.8	4.1	3.8	3.2	3.6	3.2
2.4	2.5	2.4	2	2.2	2	2.9	3.1	2.9	2.5	2.7	2.5
Test #: G1-1804-707-34						Test #: G1-1804-707-34					



Cooper Lighting Solutions
1121 Highway 74 South
Peachtree City, GA 30269
P: 770-486-4800
www.cooperlighting.com

Specifications and dimensions subject to change without notice.